



Essential to Science

Explore, Experiment, Excel



**YOUR TRUSTED PARTNER FOR SCIENTIFIC LAB
GLASSWARE, EQUIPMENTS & CONSUMABLES**

PRICE LIST



“Global” – Solutions to Keep You Moving

We at Global, strive to provide our customers with high-quality laboratory solutions mainly in the area of scientific laboratory glassware, plasticware, metalware, rubberware, porcelainware.

Global’s comprehensive line of glassware includes products for every lab. Global’s offering is separated into two distinct classes of products:
Glassware and Plasticware

Global’s range of products include a full range of components such as beakers, flasks, vials, bottles, volumetric ware as well as various custom made glass components and apparatus for filtration, distillation, extraction, and reflux processes.

Global provides products to the Clinical, Industrial, and Academic markets including schools, universities, research labs, petroleum companies, pharmaceutical, life science and diagnostic centers.

Please contact us for your custom needs.

We look forward to your support and patronage, Thank You

The management and staff of Global Antico Process Systems Pvt. Ltd. - INDIA 

INDEX

GLASSWARE.....	1
Adapters.....	2
Beakers.....	11
Bottles.....	12
Burettes.....	17
Cones.....	19
Columns.....	20
Condensers.....	30
Cylinders.....	33
Dean & Stark Receivers.....	36
Desiccators and Dishes.....	37
Distilling Apparatus.....	38
Extractors.....	40
Flasks.....	41
Funnels.....	56
Kettles.....	63
Pipettes.....	65
Stirrers.....	68
Stoppers.....	73
Sintered Glassware.....	74
Tubes.....	76
METALWARE.....	81
RUBBERWARE.....	89
PORCELINWARE.....	93
LAB EQUIPMENTS.....	118

LABORATORY CHEMICALS - AVAILABLE ON REQUEST





GLASSWARE

Essential to Science

Explore, Experiment, Excel



**YOUR TRUSTED PARTNER FOR SCIENTIFIC LAB
GLASSWARE, EQUIPMENTS & CONSUMABLES**

ADAPTERS

A01- ADAPTER

Enlarging, Interchangeable Joints

Product Code	Socket Joint Size	Cone Joint Size	Quantity Per Case	Price/ Piece ₹
A01/01	B-14	B-10	5	140.00
A01/02	B-19	B-14	5	140.00
A01/03	B-24	B-14	5	175.00
A01/04	B-24	B-19	5	210.00
A01/05	B-29	B-14	5	210.00
A01/06	B-29	B-19	5	220.00
A01/07	B-29	B-24	5	225.00
A01/08	B-34	B-19	5	250.00
A01/09	B-34	B-24	5	260.00
A01/10	B-34	B-29	5	290.00
A01/11	B-55	B-24	5	540.00
A01/12	B-55	B-34	5	620.00

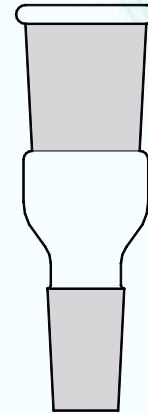

A02- ADAPTER

Reduction, Interchangeable Joints

Product Code	Socket Joint Size	Cone Joint Size	Quantity Per Case	Price/ Piece ₹
A02/01	B-10	B-14	5	140.00
A02/02	B-14	B-19	5	140.00
A02/03	B-14	B-24	5	175.00
A02/04	B-19	B-24	5	210.00
A02/05	B-14	B-29	5	210.00
A02/06	B-19	B-29	5	220.00
A02/07	B-24	B-29	5	225.00
A02/08	B-19	B-34	5	250.00
A02/09	B-24	B-34	5	260.00
A02/10	B-29	B-34	5	290.00
A02/11	B-24	B-55	5	540.00
A02/12	B-34	B-55	5	620.00

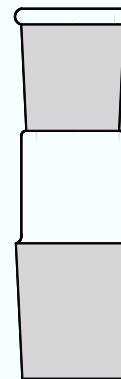

A03- ADAPTER

Receiver Bend With Vacuum Connection

Product Code	Socket Joint Size	Cone Joint Size	Quantity Per Case	Price/ Piece ₹
A03/01	B-14	B-14	5	270.00
A03/02	B-19	B-19	5	300.00
A03/03	B-24	B-24	5	380.00
A03/04	B-29	B-24	5	450.00
A03/05	B-29	B-29	5	480.00
A03/06	B-34	B-24	5	560.00
A03/07	B-34	B-34	5	650.00

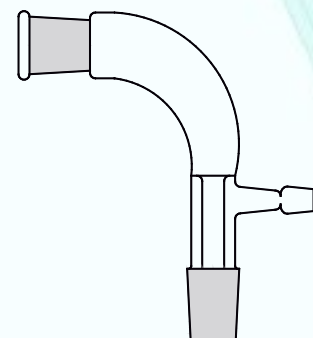

ADAPTERS

A04- ADAPTER MULTIPLE

With Two Neck Parallel

Product Code	Socket Joint Size	Cone Joint Size	Quantity Per Case	Price/ Piece ₹
A04/01	B-14	B-14	5	250.00
A04/02	B-14	B-19	5	265.00
A04/03	B-19	B-19	5	280.00
A04/04	B-14	B-24	5	290.00
A04/05	B-19	B-24	5	310.00
A04/06	B-24	B-24	5	380.00
A04/07	B-24	B-29	5	450.00
A04/08	B-29	B-29	5	550.00
A04/09	B-24	B-34	5	600.00
A04/10	B-34	B-34	5	650.00

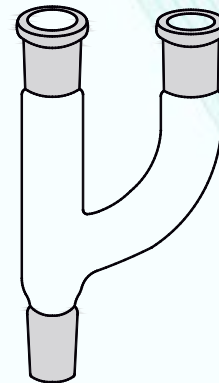

A05- ADAPTER MULTIPLE

With Two Neck - One Vertical & One at 45°

Product Code	Socket Joint Size	Cone Joint Size	Quantity Per Case	Price/ Piece ₹
A05/01	B-14	B-14	5	250.00
A05/02	B-14	B-19	5	265.00
A05/03	B-19	B-19	5	280.00
A05/04	B-14	B-24	5	290.00
A05/05	B-19	B-24	5	310.00
A05/06	B-24	B-24	5	380.00
A05/07	B-24	B-29	5	450.00
A05/08	B-29	B-29	5	550.00
A05/09	B-24	B-34	5	600.00
A05/10	B-34	B-34	5	650.00

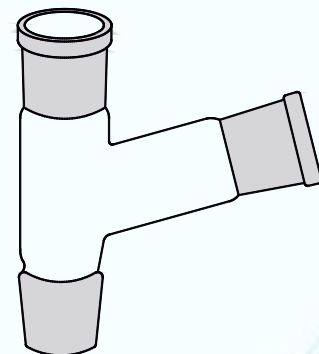

A06- ADAPTER MULTIPLE

With Two Neck - One Vertical & One at 45°

Product Code	Socket Joint Size	Cone Joint Size	Quantity Per Case	Price/ Piece ₹
A06/01	B-14	B-14	5	270.00
A06/02	B-14	B-19	5	280.00
A06/03	B-19	B-19	5	290.00
A06/04	B-14	B-24	5	320.00
A06/05	B-19	B-24	5	360.00
A06/06	B-24	B-24	5	380.00
A06/07	B-24	B-29	5	400.00
A06/08	B-29	B-29	5	425.00
A06/09	B-24	B-34	5	470.00
A06/10	B-34	B-34	5	510.00

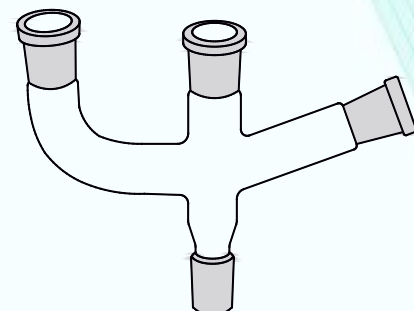

ADAPTERS

A07- ADAPTER CONE / RUBBER TUBING

Straight

Product Code	Cone Joint Size	Quantity Per Case	Price/ Piece ₹
A07/01	B-14	5	145.00
A07/02	B-19	5	150.00
A07/03	B-24	5	160.00
A07/04	B-29	5	195.00
A07/05	B-34	5	260.00
A07/06	B-45	5	350.00



A08- ADAPTER CONE / RUBBER TUBING

Bend

Product Code	Cone Joint Size	Quantity Per Case	Price/ Piece ₹
A08/01	B-14	5	145.00
A08/02	B-19	5	150.00
A08/03	B-24	5	160.00
A08/04	B-29	5	195.00
A08/05	B-34	5	260.00
A08/06	B-45	5	350.00

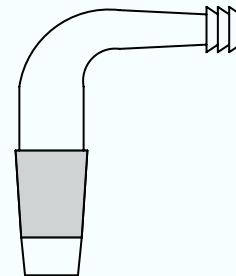

A09- ADAPTER SOCKET / FLEXIBLE TUBING

Product Code	Socket Joint Size	Quantity Per Case	Price/ Piece ₹
A09/01	B-14	5	130.00
A09/02	B-19	5	160.00
A09/03	B-24	5	170.00
A09/04	B-29	5	210.00
A09/05	B-34	5	250.00

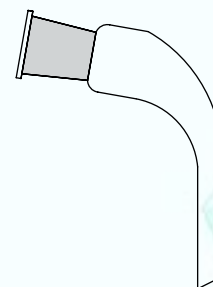

A10- ADAPTER RECEIVER

Straight Socket To Rubber

Product Code	Socket Joint Size	Quantity Per Case	Price/ Piece ₹
A10/01	B-14	5	140.00
A10/02	B-19	5	170.00
A10/03	B-24	5	195.00
A10/04	B-29	5	220.00
A10/05	B-34	5	300.00

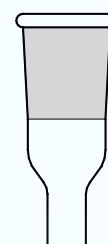

ADAPTERS

A11- ADAPTOR

Bend Cone With Stopcock

Product Code	Cone Joint Size	Quantity Per Case	Price/ Piece ₹
A11/01	B-14	5	370.00
A11/02	B-19	5	380.00
A11/03	B-24	5	430.00
A11/04	B-29	5	480.00
A11/05	B-34	5	525.00

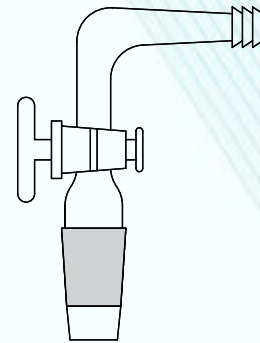

A12- ADAPTOR

Vaccum Release Stop-Cock (One Way)

Product Code	Cone Joint Size	Quantity Per Case	Price/ Piece ₹
A12/01	B-14	5	600.00
A12/02	B-19	5	620.00
A12/03	B-24	5	640.00
A12/04	B-29	5	810.00
A12/05	B-34	5	940.00

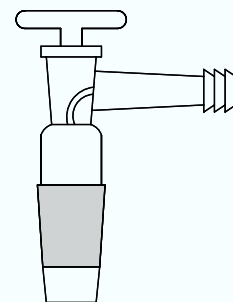

A13- ADAPTOR

Vaccum Release Stop-Cock (Two Way)

Product Code	Cone Joint Size	Quantity Per Case	Price/ Piece ₹
A13/01	B-14	5	1200.00
A13/02	B-19	5	1250.00
A13/03	B-24	5	1280.00
A13/04	B-29	5	1300.00
A13/05	B-34	5	1400.00

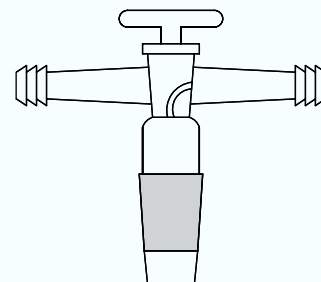

A14- ADAPTOR

Plain Bend

Product Code	Cone/ Socket Joint Size	Cone/ Socket Joint Size	Quantity Per Case	Price/ Piece ₹
A14/01	B-14	B-14	5	220.00
A14/02	B-19	B-19	5	230.00
A14/03	B-24	B-19	5	245.00
A14/04	B-24	B-24	5	245.00
A14/05	B-29	B-24	5	265.00
A14/06	B-29	B-29	5	280.00
A14/07	B-34	B-24	5	340.00
A14/08	B-34	B-34	5	440.00
A14/09	B-45	B-34	5	525.00

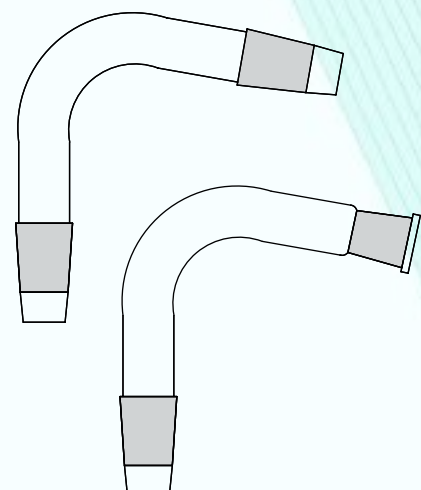

ADAPTERS

A15- SLOPING PLAIN STILL HEADS

Product Code	Flask Cone	Cond. Cone	Socket	Quantity Per Case	Price/ Piece ₹
A15/01	B-14	B-14	B-14	5	250.00
A15/02	B-19	B-19	B-19	5	280.00
A15/03	B-24	B-19	B-19	5	320.00
A15/04	B-24	B-24	B-19	5	350.00
A15/05	B-24	B-24	B-24	5	380.00
A15/06	B-29	B-24	B-19	5	450.00
A15/07	B-29	B-29	B-24	5	500.00
A15/08	B-34	B-24	B-19	5	570.00
A15/09	B-34	B-34	B-19	5	600.00
A15/10	B-34	B-34	B-24	5	650.00
A15/11	B-45	B-34	B-24	5	880.00

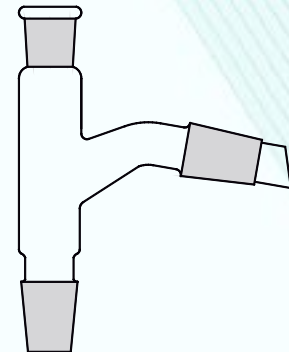

A16- CLASIN HEAD SLOPING

With 2 x B19 Thermometer Socket

Product Code	Cone For Flask	Cone For Cond.	Quantity Per Case	Price/ Piece ₹
A16/01	B-14	B-14	5	600.00
A16/02	B-19	B-19	5	700.00
A16/03	B-24	B-24	5	750.00
A16/04	B-29	B-24	5	800.00
A16/05	B-29	B-29	5	900.00
A16/06	B-34	B-24	5	980.00
A16/07	B-34	B-34	5	995.00

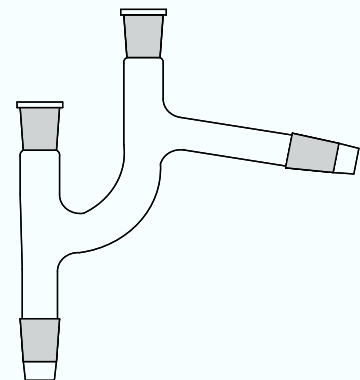

A17- SPLASH HEAD SLOPING PEAR SHAPE

Product Code	Cone For Flask	Cone For Cond.	Quantity Per Case	Price/ Piece ₹
A17/01	B-14	B-14	5	420.00
A17/02	B-19	B-19	5	440.00
A17/03	B-24	B-19	5	460.00
A17/04	B-24	B-24	5	580.00
A17/05	B-29	B-24	5	600.00
A17/06	B-29	B-29	5	620.00
A17/07	B-34	B-24	5	995.00
A17/08	B-34	B-34	5	1000.00
A17/09	B-45	B-34	5	1350.00

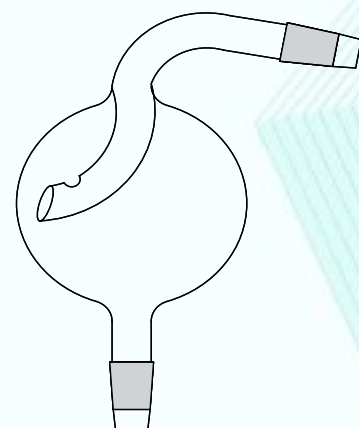

A18- SPLASH HEAD VERTICAL PEAR SHAPE

Product Code	Cone For Flask	Cone For Cond.	Quantity Per Case	Price/ Piece ₹
A18/01	B-19/14	B-19/14	5	280.00
A18/02	B-24/19	B-24/19	5	380.00
A18/03	B-34/24	B-34/24	5	575.00

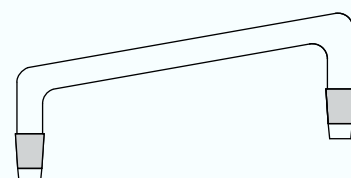

ADAPTERS

A19- SPLASH HEAD VERTICAL PEAR SHAPE

Product Code	Cone For Flask	Cone For Cond.	Quantity Per Case	Price/ Piece ₹
A19/01	B-14	B-14	5	390.00
A19/02	B-19	B-19	5	550.00
A19/03	B-24	B-19	5	550.00
A19/04	B-24	B-24	5	800.00
A19/05	B-29	B-24	5	850.00
A19/06	B-29	B-29	5	895.00
A19/07	B-34	B-24	5	950.00
A19/08	B-34	B-34	5	980.00
A19/09	B-45	B-34	5	1400.00

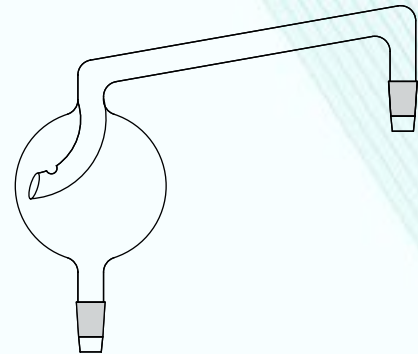

A20- ADAPTER RECEIVER

Multiple Connectivity

Product Code	Socket Joint Size	Cone Joint Size	Quantity Per Case	Price/ Piece ₹
A20/01	B-14	B-14	5	700.00
A20/02	B-19	B-19	5	750.00
A20/03	B-24	B-19	5	800.00
A20/04	B-24	B-24	5	900.00

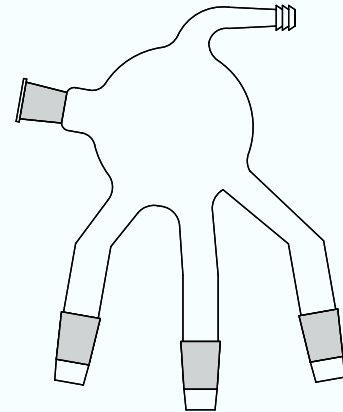

A21- ADAPTER RECEIVER

Multiple Connectivity With Vacuum Connection

Product Code	Socket Joint Size	Cone Joint Size	Quantity Per Case	Price/ Piece ₹
A21/01	B-14	B-14	5	1375.00
A21/02	B-19	B-19	5	1450.00
A21/03	B-24	B-19	5	1500.00

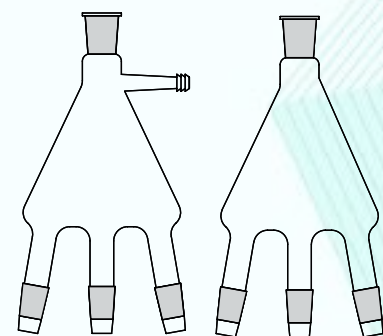

A22- GAS BUBBLER

Commonly Used as Nitrogen Bubbler

Product Code	Cone Joint Size	Quantity Per Case	Price/ Piece ₹
A22/01	B-14	5	1200.00
A22/02	B-19	5	1400.00
A22/03	B-24	5	1480.00
A22/04	B-29	5	1550.00
A22/05	B-34	5	1900.00

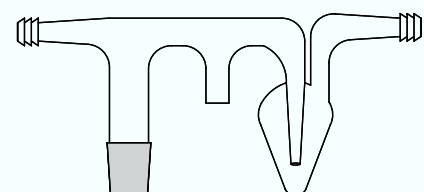

ADAPTERS

A23- ADAPTER INTERMEDIATE RECEIVER - PERKIN

Product Code	Socket Joint Size	Cone Joint Size	Quantity Per Case	Price/ Piece ₹
A23/01	B-14	B-14	5	2200.00
A23/02	B-19	B-19	5	2800.00
A23/03	B-24	B-24	5	3000.00
A23/04	B-29	B-29	5	3500.00
A23/05	B-34	B-24	5	3800.00
A23/06	B-34	B-34	5	4000.00

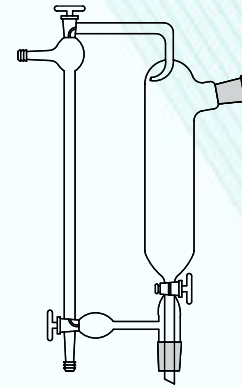

A24- GUARD TUBE

Straight Socket To Rubber

Product Code	Cone Joint Size	Quantity Per Case	Price/ Piece ₹
A24/01	B-14	5	140.00
A24/02	B-19	5	160.00
A24/03	B-24	5	190.00
A24/04	B-29	5	250.00
A24/05	B-34	5	320.00

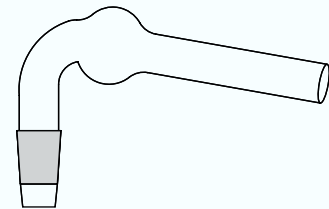

A25- INTERMEDIATE STOP-COCK ADAPTER

Product Code	Socket Joint Size	Cone Joint Size	Quantity Per Case	Price/ Piece ₹
A25/01	B-19	B-19	5	600.00
A25/02	B-24	B-24	5	720.00
A25/03	B-29	B-29	5	900.00
A25/04	B-34	B-34	5	990.00

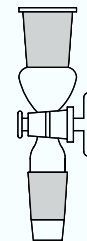

A26- REFLUX DIVIDER

With Ball Joint

Product Code	Flask Cone	TP Socket	Cond. Socket	Quantity Per Case	Price/ Piece ₹
A26/01	B-24	B-14	B-24	5	2200.00
A26/02	B-29	B-19	B-29	5	2600.00
A26/03	B-34	B-19	B-34	5	2900.00
A26/04	B-45	B-19	B-34	5	3500.00

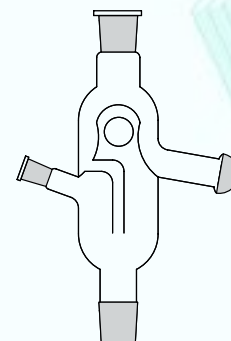

A27- Distillation Receiver Bend For Reflux Divider

Product Code	Cupe Joint	Cone	Quantity Per Case	Price/ Piece ₹
A27/01	S-19	B-14	5	1100.00
A27/02	S-29	B-24	5	1400.00

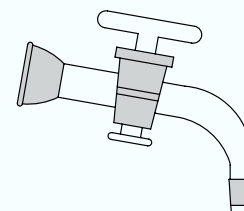

ADAPTERS

A28- GAS PURGER

Product Code	Cone For Flask	Flask Cap. (ml)	Quantity Per Case	Price/ Piece ₹
A28/01	B-14	25	5	140.00
A28/02	B-14	50	5	150.00
A28/03	B-14	100	5	160.00
A28/04	B-14	250	5	170.00
A28/05	B-19	100	5	190.00
A28/06	B-19	250	5	190.00
A28/07	B-19	500	5	220.00
A28/08	B-19	1000	5	250.00
A28/09	B-19	2000	5	290.00
A28/10	B-24	250	5	200.00
A28/11	B-24	500	5	240.00
A28/12	B-24	1000	5	265.00
A28/13	B-24	2000	5	300.00
A28/14	B-24	3000	5	340.00
A28/15	B-24	5000	5	420.00
A28/16	B-24	10000	5	525.00
A28/17	B-24	20000	5	575.00
A28/18	B-34	10000	5	540.00
A28/19	B-34	20000	5	600.00

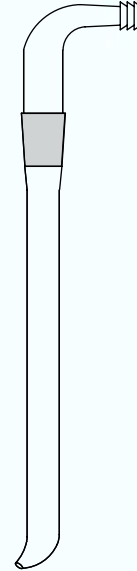

A29- Thermometer Pocket

Product Code	Cone For Flask	Flask Cap. (ml)	Quantity Per Case	Price/ Piece ₹
A29/01	B-14	25	5	140.00
A29/02	B-14	50	5	140.00
A29/03	B-14	100	5	160.00
A29/04	B-14	250	5	170.00
A29/05	B-19	100	5	180.00
A29/06	B-19	250	5	180.00
A29/07	B-19	500	5	190.00
A29/08	B-19	1000	5	200.00
A29/09	B-19	2000	5	220.00
A29/10	B-24	250	5	200.00
A29/11	B-24	500	5	220.00
A29/12	B-24	1000	5	230.00
A29/13	B-24	2000	5	240.00
A29/14	B-24	3000	5	250.00
A29/15	B-24	5000	5	300.00
A29/16	B-24	10000	5	330.00
A29/17	B-24	20000	5	360.00
A29/18	B-34	10000	5	380.00
A29/19	B-34	20000	5	450.00



ADAPTERS

A30- DIP PIPE

Product Code	Cone For Flask	Flask Cap. (ml)	Quantity Per Case	Price/ Piece ₹
A30/01	B-14	25	5	140.00
A30/02	B-14	50	5	140.00
A30/03	B-14	100	5	160.00
A30/04	B-14	250	5	170.00
A30/05	B-19	100	5	180.00
A30/06	B-19	250	5	180.00
A30/07	B-19	500	5	190.00
A30/08	B-19	1000	5	200.00
A30/09	B-19	2000	5	220.00
A30/10	B-24	250	5	200.00
A30/11	B-24	500	5	220.00
A30/12	B-24	1000	5	230.00
A30/13	B-24	2000	5	240.00
A30/14	B-24	3000	5	250.00
A30/15	B-24	5000	5	300.00
A30/16	B-24	10000	5	330.00
A30/17	B-24	20000	5	360.00
A30/18	B-34	10000	5	380.00
A30/19	B-34	20000	5	450.00



BEAKERS & BOTTLES

B01- BEAKERS

Low Form With Spout, Graduated

Product Code	Capacity ml	Quantity Per Case	Price/ Piece ₹
B01/01	5	5	35.00
B01/02	10	5	40.00
B01/03	25	5	60.00
B01/04	50	5	65.00
B01/05	100	5	70.00
B01/06	150	5	75.00
B01/07	250	5	85.00
B01/09	500	5	160.00
B01/11	1000	5	340.00
B01/12	2000	5	650.00
B01/13	3000	5	1800.00
B01/14	5000	5	2500.00
B01/15	10000	5	8000.00
B01/16	20000	5	12500.00

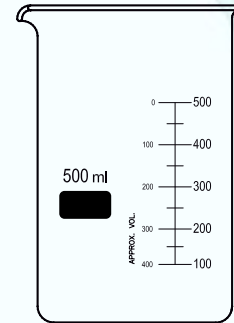

B02- BEAKERS

Phillips (Conical) With Spout

Product Code	Capacity ml	Quantity Per Case	Price/ Piece ₹
B02/01	250	5	500.00
B02/02	500	5	600.00

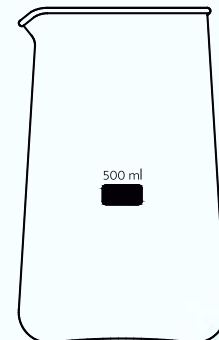

B03- REAGENT BOTTLE

Plain Narrow Mouth, With Inter - Changeable Flat Head Stopper - Clear Glass

Product Code	Capacity (ml)	Ground Joint Size	Quantity Per Case	Price/ Piece ₹
B03/01	60	B-14	5	220.00
B03/02	30	B-14	5	200.00
B03/03	125	B-19	5	300.00
B03/04	250	B-19	5	350.00
B03/05	500	B-24	5	400.00
B03/06	1000	B-29	5	660.00
B03/07	2000	B-34	5	1200.00
B03/08	3000	B-45	5	3200.00
B03/09	5000	B-45	5	5600.00
B03/10	10000	B-55	5	9500.00
B03/11	20000	B-34	5	16500.00

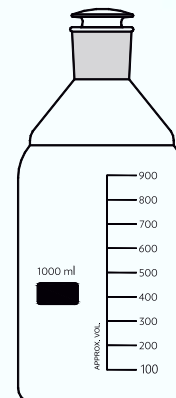

BOTTLES

B04- REAGENT BOTTLE

Plain Narrow Mouth, With Inter - Changeable Flat Head Stopper - Amber Glass

Product Code	Capacity (ml)	Ground Joint Size	Quantity Per Case	Price/ Piece ₹
B04/01	60	B-14	5	440.00
B04/02	30	B-14	5	330.00
B04/03	125	B-19	5	500.00
B04/04	250	B-19	5	650.00
B04/05	500	B-24	5	770.00
B04/06	1000	B-29	5	1200.00
B04/07	2000	B-34	5	2100.00
B04/08	3000	B-45	5	4000.00
B04/09	5000	B-45	5	9000.00
B04/10	10000	B-45	5	12500.00
B04/11	20000	B-45	5	19800.00



B05- TOOLED NECK BOTTLES

Solution Bottle, Plain

Product Code	Capacity (ml)	Ground Joint Size	Quantity Per Case	Price/ Piece ₹
B05/01	60	B-14	5	220.00
B05/02	30	B-14	5	200.00
B05/03	125	B-19	5	300.00
B05/04	250	B-19	5	350.00
B05/05	500	B-24	5	400.00
B05/06	1000	B-29	5	660.00
B05/07	2000	B-34	5	1200.00
B05/08	3000	B-45	5	3200.00
B05/09	5000	B-45	5	5600.00
B05/10	10000	B-55	5	9500.00
B05/11	20000	B-34	5	16500.00

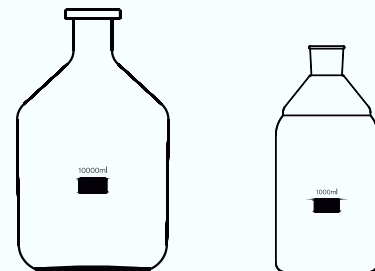

B06- TOOLED NECK BOTTLES

Solution Bottle, Amber

Product Code	Capacity (ml)	Ground Joint Size	Quantity Per Case	Price/ Piece ₹
B06/01	60	B-14	5	440.00
B06/02	30	B-14	5	330.00
B06/03	125	B-19	5	500.00
B06/04	250	B-19	5	650.00
B06/05	500	B-24	5	770.00
B06/06	1000	B-29	5	1200.00
B06/07	2000	B-34	5	2100.00
B06/08	3000	B-45	5	4000.00
B06/09	5000	B-45	5	9000.00
B06/10	10000	B-45	5	12500.00
B06/11	20000	B-45	5	19800.00

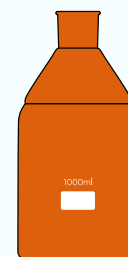

B07- STOPPER

Product Code	Description	Joint Size	Quantity Per Case	Price/ Piece ₹
B07/01	Solid	B-14	5	60.00
B07/02	Solid	B-19	5	75.00
B07/03	Solid	B-24	5	110.00
B07/04	Solid	B-29	5	200.00
B07/05	Solid	B-34	5	280.00
B07/06	Hollow	B-45	5	250.00



BOTTLES

B08- REAGENT BOTTLE

With Screw Cap - Clear Glass

Product Code	Capacity (ml)	Thread Specification	Quantity Per Case	Price/ Piece ₹
B08/01	25	GL-25	5	240.00
B08/02	50	GL-32	5	260.00
B08/03	100	GL-45	5	330.00
B08/04	250	GL-45	5	350.00
B08/05	500	GL-45	5	400.00
B08/06	1000	GL-45	5	650.00
B08/07	2000	GL-45	5	1300.00
B08/08	3000	GL-45	5	4500.00
B08/09	5000	GL-45	5	5800.00
B08/10	10000	GL-45	5	9900.00
B08/11	20000	GL-45	5	19000.00

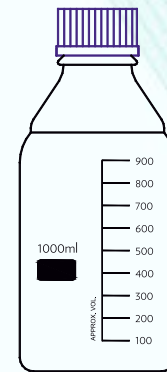

B09- REAGENT BOTTLE

With Screw Cap - Amber Glass

Product Code	Capacity (ml)	Thread Specification	Quantity Per Case	Price/ Piece ₹
B09/01	25	GL-25	5	400.00
B09/02	50	GL-32	5	500.00
B09/03	100	GL-45	5	550.00
B09/04	250	GL-45	5	600.00
B09/05	500	GL-45	5	750.00
B09/06	1000	GL-45	5	1000.00
B09/07	2000	GL-45	5	1800.00
B09/08	3000	GL-45	5	6500.00
B09/09	5000	GL-45	5	9950.00
B09/10	10000	GL-45	5	14000.00
B09/11	20000	GL-45	5	22950.00



B10- Aspirator Bottles

With Screw Cap & Tubulation

Product Code	Capacity (ml)	Quantity Per Case	Price/ Piece ₹
B10/01	250	5	450.00
B10/02	500	5	560.00
B10/03	1000	5	890.00
B10/04	2000	5	1400.00

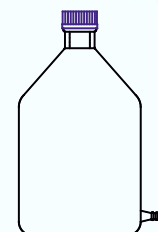

B11- Aspirator Bottles

With Socket Outlet for stopcock with screw cap

Product Code	Capacity (ml)	Quantity Per Case	Price/ Piece ₹
B11/01	500	5	950.00
B11/02	1000	5	1600.00
B11/03	2000	5	2800.00
B11/04	5000	5	6900.00
B11/05	10000	5	12000.00
A11/06	20000	5	14500.00

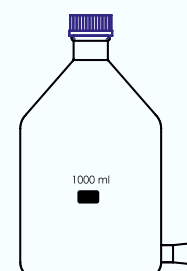

BOTTLES

B12- Aspirator Bottles

Without Stopper & With Tubulation

Product Code	Capacity (ml)	Quantity Per Case	Price/ Piece ₹
B12/01	125	5	420.00
B12/02	250	5	450.00
B12/03	500	5	560.00
B12/04	1000	5	880.00
B12/05	2000	5	1300.00

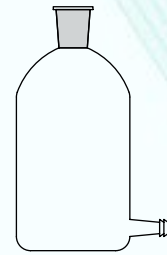

B13- Aspirator Bottles

With Stop Cock & Glass Stopper

Product Code	Capacity (ml)	Quantity Per Case	Price/ Piece ₹
B13/01	1000	5	2500.00
B13/02	2000	5	2800.00
B13/03	5000	5	10,500.00
B13/04	10000	5	15,000.00
B13/05	20000	5	19,500.00
B13/06	500	5	1400.00

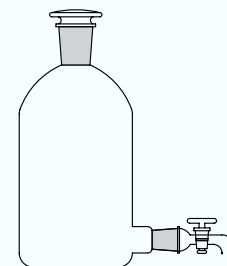

B14- B.O.D BOTTLES

With Interchangeable Stopper

Product Code	Capacity (ml)	Quantity Per Case	Price/ Piece ₹
B14/01	125	5	420.00
B14/02	300	5	650.00



B15- RELATIVE DENSITY BOTTLES

Class A with Certificate

Product Code	Capacity (ml)	Quantity Per Case	Price/ Piece ₹
B15/01	10	5	800.00
B15/02	25	5	950.00
B15/03	50	5	990.00

Class B

Product Code	Capacity (ml)	Quantity Per Case	Price/ Piece ₹
B15/04	10	5	280.00
B15/05	25	5	350.00
B15/06	50	5	400.00

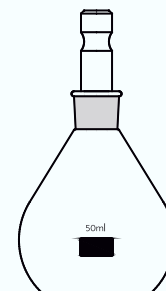

BOTTLES

B16- WEIGHING BOTTLE

With Interchangeable Lids

Product Code	Capacity (ml)	O.D. X Height mm	Quantity Per Case	Price/ Piece ₹
B16/01	5	20 x 40	5	350.00
B16/02	15	25 x 65	5	380.00
B16/03	20	50 x 35	5	425.00
B16/04	25	30 x 65	5	500.00
B16/05	40	60 x 40	5	550.00
B16/06	75	80 x 50	5	1000.00

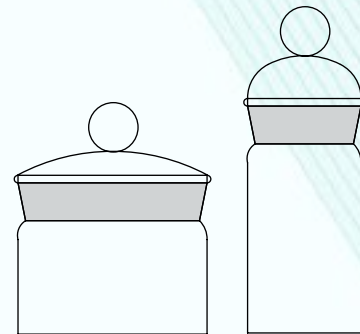

B17- SPECIFIC GRAVITY BOTTLE

With Thermometer(Pyknometer)

Product Code	Capacity (ml)	Quantity Per Case	Price/ Piece ₹
B17/01	10	5	1600.00
B17/02	25	5	1650.00
B17/03	50	5	1800.00

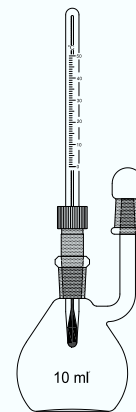

B18- DROPPING BOTTLES

With Dropper & Rubber Teat

Product Code	Capacity (ml)	Socket Size	Quantity Per Case	Price/ Piece ₹
B18/01	30	B-14	5	200.00
B18/02	60	B-14	5	220.00
B18/03	125	B-29	5	290.00
B18/04	250	B-19	5	450.00



B19- DROPPING BOTTLES

With Dropper & Rubber Teat, Amber

Product Code	Capacity (ml)	Socket Size	Quantity Per Case	Price/ Piece ₹
B19/01	30	B-14	5	300.00
B19/02	60	B-14	5	370.00
B19/03	125	B-29	5	425.00
B19/04	250	B-19	5	600.00



B20- GAS WASH BOTTLES

With Interchangeable Stopper

Product Code	Capacity (ml)	Ground Joint	Quantity Per Case	Price/ Piece ₹
B20/01	250	B-14	5	990.00
B20/02	500	B-14	5	1200.00
B20/03	1000	B-29	5	1800.00
B20/04	2000	B-19	5	2400.00

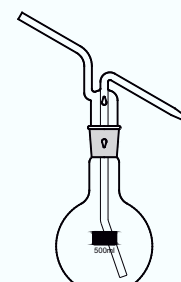

BOTTLES

B21- STOPPERS

For Wash Bottles

Product Code	Capacity ml	Ground Joint	Quantity Per Case	Price/ Piece ₹
B21/01	250	B-24	5	365.00
B21/02	500	B-24	5	410.00
B21/03	1000	B-29	5	600.00
B21/04	2000	B-29	5	850.00

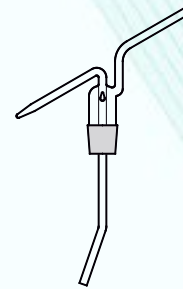

B22- GAS WASHING(DRESCHEL) BOTTLES

Set With Interchangeable Stopper

Product Code	Capacity ml	Ground Joint	Quantity Per Case	Price/ Piece ₹
B22/01	125	B-29	5	990.00
B22/02	250	B-29	5	1100.00
B22/03	500	B-29	5	1200.00

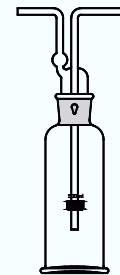

B23- STOPPERS

For Gas Washing Bottles

Product Code	Capacity ml	Ground Joint	Quantity Per Case	Price/ Piece ₹
B23/01	125	B-29	5	320.00
B23/02	250	B-29	5	365.00
B23/03	500	B-29	5	410.00

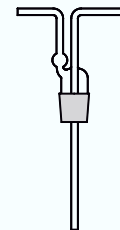

B24- BOTTLES

For Gas Washing Bottles

Product Code	Capacity ml	Ground Joint	Quantity Per Case	Price/ Piece ₹
B24/01	125	B-29	5	500.00
B24/02	250	B-29	5	550.00
B24/03	500	B-29	5	695.00

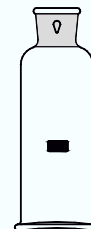

B25- IMPINGER

Product Code	Capacity ml	Quantity Per Case	Price/ Piece ₹
B25/01	35	5	650.00
B25/02	50	5	780.00
B25/03	80	5	800.00
B25/04	100	5	850.00
B25/05	150	5	1300.00
B25/06	250	5	1450.00
B25/07	275	5	1600.00



B26- GAS BUBBLING (VACUUM TRAP)

Product Code	Capacity (ml)	Quantity Per Case	Price/ Piece ₹
B26/01	125	5	600.00
B26/02	250	5	680.00
B26/03	500	5	900.00

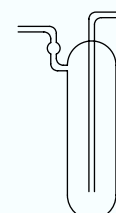

BURETTES

B27- BURETTES WITH PTFE ROTAFLOW (CLASS A)

IS 1997:2008/EN ISO 385, With Certificate, Clear Glass

Product Code	Capacity ml	Graduation Interval ml	Tolerance \pm ml	Price/ Piece ₹
B27/01	10	0.050	0.020	2365.00
B27/02	25	0.100	0.050	2515.00
B27/03	50	0.100	0.050	2745.00
B27/04	100	0.200	0.100	3855.00

B28- BURETTES WITH PTFE ROTAFLOW (CLASS B)

Clear Glass

Product Code	Capacity ml	Graduation Interval ml	Tolerance \pm ml	Price/ Piece ₹
B28/01	10	0.050	0.050	760.00
B28/02	25	0.100	0.100	720.00
B28/03	50	0.100	0.100	800.00
B28/04	100	0.200	0.200	1205.00

B29- BURETTES WITH GLASS STOPCOCK (CLASS A)

IS 1997:2008/EN ISO 385, With Certificate, Clear Glass

Product Code	Capacity ml	Graduation Interval ml	Tolerance \pm ml	Price/ Piece ₹
B29/01	10	0.050	0.020	2645.00
B29/02	25	0.100	0.050	2600.00
B29/03	50	0.100	0.050	2955.00
B29/04	100	0.200	0.100	4260.00

B30- BURETTES WITH GLASS STOPCOCK (CLASS B)

Clear Glass

Product Code	Capacity ml	Graduation Interval ml	Tolerance \pm ml	Price/ Piece ₹
B30/01	10	0.050	0.050	865.00
B30/02	25	0.100	0.100	840.00
B30/03	50	0.100	0.100	915.00
B30/04	100	0.200	0.200	1280.00

B31- BURETTES WITH PTFE STOPCOCK (CLASS A)

IS 1997:2008/EN ISO 385, With Certificate, Clear Glass

Product Code	Capacity ml	Graduation Interval ml	Tolerance \pm ml	Price/ Piece ₹
B31/01	10	0.050	0.020	2365.00
B31/02	25	0.100	0.050	2515.00
B31/03	50	0.100	0.050	2745.00
B31/04	100	0.200	0.100	3855.00

B 28



B 29

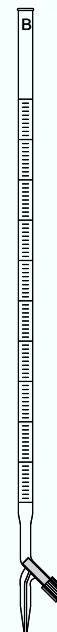

B 30



B 31



B 32



BURETTES

B32- BURETTES WITH PTFE STOPCOCK (CLASS B)

Clear Glass

Product Code	Capacity ml	Graduation Interval ml	Tolerance \pm ml	Price/ Piece ₹
B32/01	10	0.050	0.020	865.00
B32/02	25	0.100	0.050	840.00
B32/03	50	0.100	0.050	915.00
B32/04	100	0.200	0.100	1280.00



B33- BURETTES

Automatic Zero, Accuracy as per Class A of IS 1997:2008/EN ISO 385, With Reservoir Rubber Bellow, Glass Stopcock, With Certificate

Product Code	Capacity ml	Graduation Interval ml	Tolerance \pm ml	Price/ Piece ₹
B33/01	10	0.050	0.020	10,010.00
B33/02	25	0.100	0.050	9690.00
B33/03	50	0.100	0.050	10,835.00
B33/04	100	0.200	0.100	12,335.00

B34- BURETTES

Automatic Zero, Accuracy as per Class B With Reservoir, Rubber Bellow, Glass Stopcock

Product Code	Capacity ml	Graduation Interval ml	Tolerance \pm ml	Price/ Piece ₹
B34/01	10	0.050	0.020	6570.00
B34/02	25	0.100	0.050	6460.00
B34/03	50	0.100	0.050	7000.00
B34/04	100	0.200	0.100	7975.00

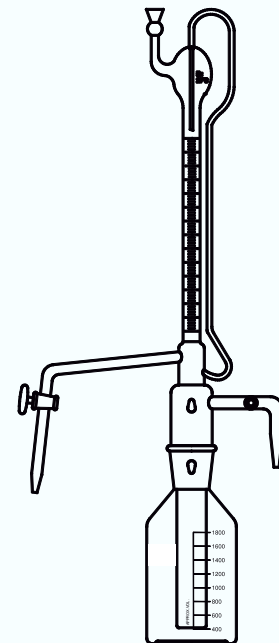

B35- BURETTES

Automatic Zero, Accuracy as per Class A of IS 1997:2008/EN ISO 385, With Reservoir Rubber Bellow, PTFE Stopcock, With Certificate

Product Code	Capacity ml	Graduation Interval ml	Tolerance \pm ml	Price/ Piece ₹
B35/01	10	0.050	0.020	10,560.00
B35/02	25	0.100	0.050	10,320.00
B35/03	50	0.100	0.050	11,445.00
B35/04	100	0.200	0.100	13,085.00

B36- BURETTES

Automatic Zero, Accuracy as per Class B With Reservoir, Rubber Bellow, PTFE Stopcock

Product Code	Capacity ml	Graduation Interval ml	Tolerance \pm ml	Price/ Piece ₹
B36/01	10	0.050	0.020	6930.00
B36/02	25	0.100	0.050	6785.00
B36/03	50	0.100	0.050	7370.00
B36/04	100	0.200	0.100	8365.00

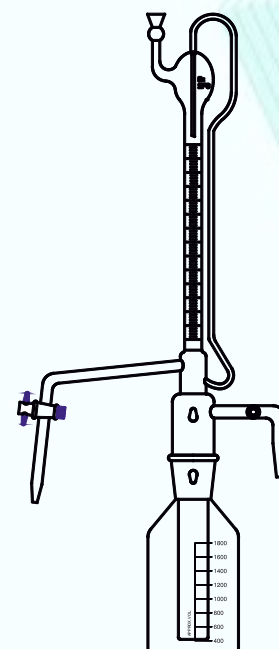

BURETTES & CONES

B37- BURETTES

Automatic Zero, Accuracy as per Class A of IS 1997:2008/EN ISO 385, With Reservoir Rubber Bellow, PTFE Stopcock, Amber With Certificate

Product Code	Capacity ml	Graduation Interval ml	Tolerance \pm ml	Price/ Piece ₹
B37/01	10	0.050	0.020	21,350.00
B37/02	25	0.100	0.050	22,790.00
B37/03	50	0.100	0.050	24,955.00
B37/04	100	0.200	0.100	26,115.00

B38- BURETTES

Automatic Zero, Accuracy as per Class B With Reservoir, Rubber Bellow, PTFE Stopcock, Amber

Product Code	Capacity ml	Graduation Interval ml	Tolerance \pm ml	Price/ Piece ₹
B38/01	10	0.050	0.020	14,565.00
B38/02	25	0.100	0.050	13,700.00
B38/03	50	0.100	0.050	14,065.00
B38/04	100	0.200	0.100	14,710.00

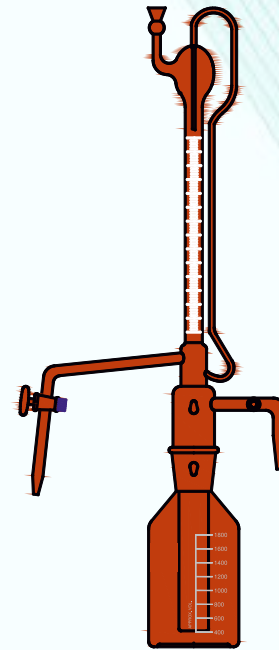

C01- CONES

Imhoff, Sediment, Sharp Tip

Product Code	Approximate Height	Approximate Diameter	Quantity Per Case	Price/ Piece ₹
C01/01	454	105	1	7000.00

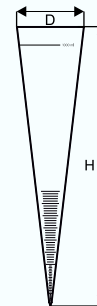

C02- CONES

Imhoff, Sediment, Blunt Tip

Product Code	Approximate Height	Approximate Diameter	Quantity Per Case	Price/ Piece ₹
C02/01	439	105	1	7000.00

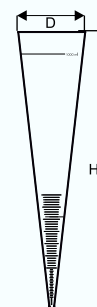

COLUMNS

C03- COLUMNS- FRACTIONATING

With Support for Rasching Ring

Product Code	Cone/ Socket	Effective Length	Quantity Per Case	Price/ Piece ₹
C03/01	B-14/14	150	5	280.00
C03/02	B-14/14	200	5	290.00
C03/03	B-14/14	300	5	310.00
C03/04	B-19/19	150	5	310.00
C03/05	B-19/19	200	5	330.00
C03/06	B-19/19	300	5	350.00
C03/07	B-24/24	150	5	430.00
C03/08	B-24/24	200	5	440.00
C03/09	B-24/24	300	5	490.00
C03/10	B-24/24	450	5	580.00
C03/11	B-24/24	600	5	610.00
C03/12	B-29/29	300	5	570.00
C03/13	B-29/29	450	5	650.00
C03/14	B-29/29	600	5	710.00
C03/15	B-34/34	300	5	730.00
C03/16	B-34/34	450	5	850.00
C03/17	B-34/34	600	5	880.00
C03/18	B-34/34	750	5	1180.00
C03/19	B-34/34	1000	5	1360.00
C03/20	B-55/55	450	5	1900.00
C03/21	B-55/55	600	5	2170.00
C03/22	B-55/55	750	5	2650.00
C03/23	B-55/55	1000	5	3400.00

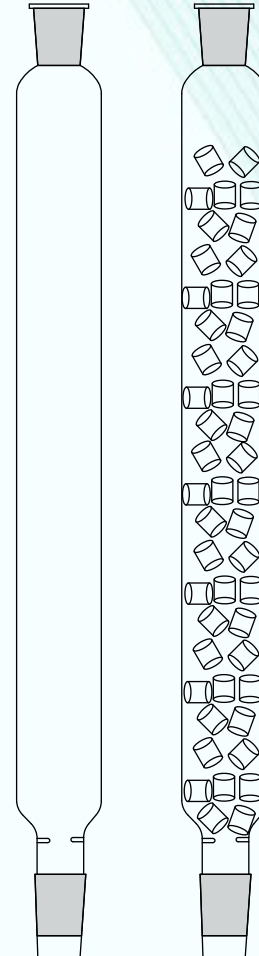

C04- Column Packing - Rasching Rings

Neutral Glass

Product Code	Size D x L (mm)	Quantity Per Case(kg.)	Price/ kg ₹
C04/01	8 x 8	5	800.00
C04/02	10 x 10	5	800.00
C04/03	12 x 12	5	950.00
C04/04	15 x 15	5	950.00

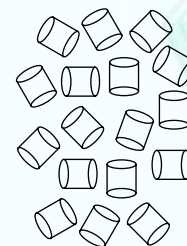

C05- Column Packing - Rasching Rings

Borosilicate Glass

Product Code	Size D x L (mm)	Quantity Per Case(kg.)	Price/ kg ₹
C05/01	8 x 8	5	1600.00
C05/02	10 x 10	5	1600.00
C05/03	12 x 12	5	1600.00
C05/04	15 x 15	5	1600.00

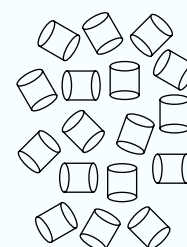

COLUMNS

C06- COLUMNS- FRACTIONATING

Vigreux

Product Code	Cone/ Socket	Effective Length	Quantity Per Case	Price/ Piece ₹
C06/01	B-14/14	150	5	390.00
C06/02	B-14/14	200	5	410.00
C06/03	B-14/14	300	5	450.00
C06/04	B-19/19	150	5	450.00
C06/05	B-19/19	200	5	460.00
C06/06	B-19/19	300	5	490.00
C06/07	B-24/24	150	5	600.00
C06/08	B-24/24	200	5	630.00
C06/09	B-24/24	300	5	720.00
C06/10	B-24/24	450	5	840.00
C06/11	B-24/24	600	5	900.00
C06/12	B-29/29	300	5	840.00
C06/13	B-29/29	450	5	960.00
C06/14	B-29/29	600	5	1170.00
C06/15	B-34/34	300	5	1080.00
C06/16	B-34/34	450	5	1290.00
C06/17	B-34/34	600	5	1320.00
C06/18	B-34/34	750	5	1740.00
C06/19	B-55/55	450	5	2910.00
C06/20	B-55/55	600	5	3270.00
C06/21	B-55/55	750	5	4100.00

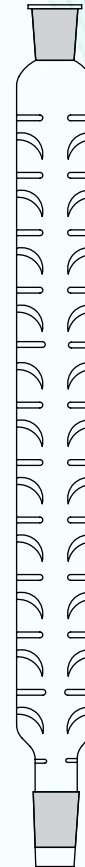

C07- COLUMNS- CHROMATOGRAPHY

Plain With Outlet for Rubber Tubing

Product Code	Size (mm) I.D. X O.D.	Effective Length	Quantity Per Case	Price/ Piece ₹
C07/01	20 x 24	200	5	190.00
C07/02	20 x 24	300	5	220.00
C07/03	20 x 24	375	5	250.00
C07/04	20 x 24	450	5	300.00
C07/05	24 x 28	200	5	220.00
C07/06	24 x 28	300	5	260.00
C07/07	24 x 28	375	5	280.00
C07/08	24 x 28	450	5	370.00
C07/09	24 x 28	600	5	460.00
C07/10	30 x 34	300	5	300.00
C07/11	30 x 34	375	5	350.00
C07/12	30 x 34	450	5	430.00
C07/13	30 x 34	600	5	540.00
C07/14	30 x 34	750	5	730.00
C07/15	45 x 50	450	5	520.00
C07/16	45 x 50	600	5	610.00
C07/17	45 x 50	750	5	940.00
C07/18	45 x 50	900	5	1000.00
C07/19	45 x 50	1000	5	1090.00



COLUMNS

C08- COLUMNS- CHROMATOGRAPHY

With Straight Bore Glass Stop- Cock/ PTFE Rotaflow Stop- Cock

Product Code	Size (mm) I.D. X O.D.	Effective Length(mm)	Quantity Per Case	Price/ Piece ₹
C08/01	20 x 24	200	5	410.00
C08/02	20 x 24	300	5	440.00
C08/03	20 x 24	375	5	470.00
C08/04	20 x 24	450	5	560.00
C08/05	24 x 28	250	5	470.00
C08/06	24 x 28	300	5	500.00
C08/07	24 x 28	375	5	530.00
C08/08	24 x 28	450	5	620.00
C08/09	24 x 28	600	5	660.00
C08/10	30 x 34	300	5	540.00
C08/11	30 x 34	375	5	560.00
C08/12	30 x 34	450	5	710.00
C08/13	30 x 34	600	5	800.00
C08/14	30 x 34	750	5	970.00
C08/15	45 x 50	450	5	860.00
C08/16	45 x 50	600	5	920.00
C08/17	45 x 50	750	5	1400.00
C08/18	45 x 50	900	5	1500.00
C08/19	45 x 50	1000	5	1550.00
C08/20	55 x 60	600	5	1300.00
C08/21	55 x 60	750	5	2000.00
C08/22	55 x 60	900	5	2100.00
C08/23	55 x 60	1000	5	2200.00
C08/24	65 x 70	600	5	1400.00
C08/25	65 x 70	750	5	2450.00
C08/26	65 x 70	900	5	2600.00
C08/27	65 x 70	1000	5	2810.00
C08/28	95 x 100	900	5	4010.00
C08/29	95 x 100	1000	5	4200.00
C08/30	95 x 100	1200	5	4360.00



C09- COLUMNS- CHROMATOGRAPHY

With PTFE Stop- Cock

Product Code	Size (mm) I.D. X O.D.	Effective Length(mm)	Quantity Per Case	Price/ Piece ₹
C09/01	20 x 24	200	5	590.00
C09/02	20 x 24	300	5	620.00
C09/03	20 x 24	375	5	650.00
C09/04	20 x 24	450	5	740.00
C09/05	24 x 28	250	5	650.00
C09/06	24 x 28	300	5	680.00
C09/07	24 x 28	375	5	710.00
C09/08	24 x 28	450	5	800.00
C09/09	24 x 28	600	5	840.00
C09/10	30 x 34	300	5	720.00
C09/11	30 x 34	375	5	740.00

COLUMNS

C09/12	30 x 34	450	5	890.00
C09/13	30 x 34	600	5	980.00
C09/14	30 x 34	750	5	1250.00
C09/15	45 x 50	450	5	1220.00
C09/16	45 x 50	600	5	1340.00
C09/17	45 x 50	750	5	1760.00
C09/18	45 x 50	900	5	1820.00
C09/19	45 x 50	1000	5	1900.00
C09/20	55 x 60	600	5	1640.00
C09/21	55 x 60	750	5	2300.00
C09/22	55 x 60	900	5	2450.00
C09/23	55 x 60	1000	5	2600.00
C09/24	65 x 70	600	5	2790.00
C09/25	65 x 70	750	5	2900.00
C09/26	65 x 70	900	5	3080.00
C09/27	65 x 70	1000	5	3260.00
C09/28	95 x 100	900	5	4340.00
C09/29	95 x 100	1000	5	4580.00
C09/30	95 x 100	1200	5	4800.00



C10- COLUMNS- CHROMATOGRAPHY WITH RESERVOIR

With Straight Bore Glass Stop- Cock/ PTFE Rotaflow Stop- Cock

Product Code	Size (mm) I.D. X O.D.	Effective Length(mm)	Reservoir Capacity(ml)	Price/ Piece ₹
C10/01	20 x 24	200	100	690.00
C10/02	20 x 24	300	100	720.00
C10/03	20 x 24	375	100	750.00
C10/04	20 x 24	450	100	840.00
C10/05	24 x 28	250	250	790.00
C10/06	24 x 28	300	250	820.00
C10/07	24 x 28	375	250	850.00
C10/08	24 x 28	450	250	940.00
C10/09	24 x 28	600	250	980.00
C10/10	30 x 34	300	500	1060.00
C10/11	30 x 34	375	500	1080.00
C10/12	30 x 34	450	500	1230.00
C10/13	30 x 34	600	500	1320.00
C10/14	30 x 34	750	500	1590.00
C10/15	45 x 50	450	1000	1820.00
C10/16	45 x 50	600	1000	1880.00
C10/17	45 x 50	750	1000	2900.00
C10/18	45 x 50	900	1000	3020.00
C10/19	45 x 50	1000	1000	3200.00
C10/20	55 x 60	600	2000	2900.00
C10/21	55 x 60	750	2000	4460.00
C10/22	55 x 60	900	2000	4550.00
C10/23	65 X 70	600	3000	4250.00
C10/24	65 x 70	750	3000	6500.00
C10/25	65 x 70	900	3000	6680.00

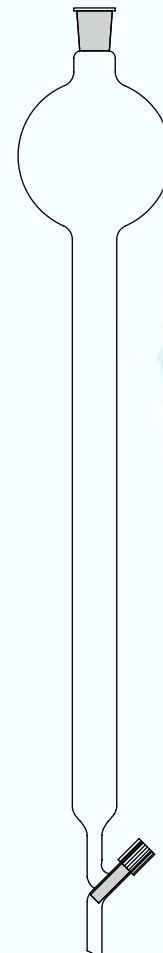

COLUMNS

C11- COLUMNS- CHROMATOGRAPHY WITH RESERVOIR

With PTFE Stop- Cock

Product Code	Size (mm) I.D. X O.D.	Effective Length(mm)	Reservoir Capacity(ml)	Price/ Piece ₹
C11/01	20 x 24	200	100	870.00
C11/02	20 x 24	300	100	900.00
C11/03	20 x 24	375	100	930.00
C11/04	20 x 24	450	100	1020.00
C11/05	24 x 28	250	250	970.00
C11/06	24 x 28	300	250	1000.00
C11/07	24 x 28	375	250	1030.00
C11/08	24 x 28	450	250	1130.00
C11/09	24 x 28	600	250	1220.00
C11/10	30 x 34	300	500	1220.00
C11/11	30 x 34	375	500	1250.00
C11/12	30 x 34	450	500	1400.00
C11/13	30 x 34	600	500	1550.00
C11/14	30 x 34	750	500	1790.00
C11/15	45 x 50	450	1000	2200.00
C11/16	45 x 50	600	1000	2200.00
C11/17	45 x 50	750	1000	3200.00
C11/18	45 x 50	900	1000	3350.00
C11/19	45 x 50	1000	1000	3500.00
C11/20	55 x 60	600	2000	3200.00
C11/22	55 x 60	750	2000	4790.00
C11/23	55 x 60	900	2000	4880.00
C11/24	65 X 70	600	3000	4700.00
C11/25	65 x 70	750	3000	7100.00
C11/26	65 x 70	900	3000	7400.00

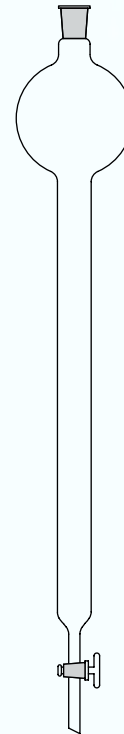

C12- COLUMNS- CHROMATOGRAPHY

With Ground Joint (Socket) on Top and Straight Bore Glass Stop- Cock/ PTFE Rotaflow Stop- Cock

Product Code	Size (mm) I.D. X O.D.	Effective Length(mm)	Socket Size	Price/ Piece ₹
C12/01	20 x 24	200	B-19	500.00
C12/02	20 x 24	300	B-19	550.00
C12/03	20 x 24	375	B-19	560.00
C12/04	20 x 24	450	B-19	650.00
C12/05	24 x 28	250	B-24	570.00
C12/06	24 x 28	300	B-24	600.00
C12/07	24 x 28	375	B-24	630.00
C12/08	24 x 28	450	B-24	720.00
C12/09	24 x 28	600	B-24	770.00
C12/10	30 x 34	300	B-24	650.00
C12/11	30 x 34	375	B-24	670.00
C12/12	30 x 34	450	B-24	830.00
C12/13	30 x 34	600	B-24	920.00
C12/14	30 x 34	750	B-24	1200.00
C12/15	45 x 50	450	B-34	1100.00
C12/16	45 x 50	600	B-34	1170.00



COLUMNS

C12/17	45 x 50	750	B-34	1550.00
C12/18	45 x 50	900	B-34	1670.00
C12/19	45 x 50	1000	B-34	1730.00
C12/20	55 x 60	600	B-34	1550.00
C12/21	55 x 60	750	B-34	2270.00
C12/22	55 x 60	900	B-34	2360.00
C12/23	55 x 60	1000	B-34	2580.00
C12/24	65 x 70	600	B-34	1700.00
C12/25	65 x 70	750	B-34	2750.00
C12/26	65 x 70	900	B-34	2900.00
C12/27	65 x 70	1000	B-34	3200.00
C12/28	95 x 100	900	B-34	4520.00
C12/29	95 x 100	1000	B-34	4800.00
C12/30	95 x 100	1200	B-34	5000.00

C13- COLUMNS- CHROMATOGRAPHY

With Ground Joint (Socket) on Top and Straight Bore Glass PTFE Stop- Cock

Product Code	Size (mm) I.D. X O.D.	Effective Length(mm)	Socket Size	Price/ Piece ₹
C13/01	20 x 24	200	B-19	700.00
C13/02	20 x 24	300	B-19	730.00
C13/03	20 x 24	375	B-19	870.00
C13/04	20 x 24	450	B-19	860.00
C13/05	24 x 28	250	B-24	780.00
C13/06	24 x 28	300	B-24	810.00
C13/07	24 x 28	375	B-24	840.00
C13/08	24 x 28	450	B-24	930.00
C13/09	24 x 28	600	B-24	980.00
C13/10	30 x 34	300	B-24	890.00
C13/11	30 x 34	375	B-24	920.00
C13/12	30 x 34	450	B-24	1070.00
C13/13	30 x 34	600	B-24	1200.00
C13/14	30 x 34	750	B-24	1430.00
C13/15	45 x 50	450	B-34	1250.00
C13/16	45 x 50	600	B-34	1310.00
C13/17	45 x 50	750	B-34	1790.00
C13/18	45 x 50	900	B-34	1910.00
C13/19	45 x 50	1000	B-34	1970.00
C13/20	55 x 60	600	B-34	1820.00
C13/21	55 x 60	750	B-34	2540.00
C13/22	55 x 60	900	B-34	2630.00
C13/23	55 x 60	1000	B-34	2750.00
C13/24	65 x 70	600	B-34	2000.00
C13/25	65 x 70	750	B-34	3050.00
C13/26	65 x 70	900	B-34	3200.00
C13/27	65 x 70	1000	B-34	3470.00
C13/28	95 x 100	900	B-34	5180.00
C13/29	95 x 100	1000	B-34	5300.00
C13/30	95 x 100	1200	B-34	5600.00



COLUMNS

C14- COLUMNS- CHROMATOGRAPHY

With Straight Bore Glass Stop- Cock/ PTFE Rotaflow Stop- Cock
Sintered Disc With Porosity Grade G0 to G4

Product Code	Size (mm) I.D.	Effective Length	Quantity Per Case	Price/ Piece ₹
C14/01	20	150	5	720.00
C14/02	20	200	5	750.00
C14/03	20	300	5	810.00
C14/04	20	375	5	830.00
C14/05	20	450	5	930.00
C14/06	30	250	5	930.00
C14/07	30	300	5	960.00
C14/08	30	375	5	990.00
C14/09	30	450	5	1070.00
C14/10	30	600	5	1290.00
C14/11	30	750	5	1650.00
C14/12	40	375	5	1470.00
C14/13	40	450	5	1710.00
C14/14	40	600	5	1920.00
C14/15	40	750	5	2460.00
C14/16	40	900	5	2550.00
C14/17	65	600	5	2700.00
C14/18	65	750	5	3300.00
C14/19	65	900	5	3900.00



C15- COLUMNS- CHROMATOGRAPHY

With Straight Bore PTFE Stop- Cock
Sintered Disc With Porosity Grade G0 to G4

Product Code	Size (mm) I.D.	Effective Length	Quantity Per Case	Price/ Piece ₹
C15/01	20	150	5	930.00
C15/02	20	200	5	990.00
C15/03	20	300	5	1020.00
C15/04	20	375	5	1050.00
C15/05	20	450	5	1170.00
C15/06	30	250	5	1170.00
C15/07	30	300	5	1200.00
C15/08	30	375	5	1260.00
C15/09	30	450	5	1470.00
C15/10	30	600	5	1560.00
C15/11	30	750	5	1920.00
C15/12	40	375	5	1830.00
C15/13	40	450	5	2100.00
C15/14	40	600	5	2280.00
C15/15	40	750	5	2800.00
C15/16	40	900	5	3000.00
C15/17	65	600	5	3180.00
C15/18	65	750	5	3810.00
C15/19	65	900	5	4450.00



COLUMNS

C16- COLUMNS- CHROMATOGRAPHY WITH RESERVOIR

With Straight Bore Glass Stop- Cock/ PTFE Rotaflow Stop- Cock
Sintered Disc With Porosity Grade G0 to G4

Product Code	Size (mm) I.D.	Effective Length	Reservoir Capacity(ml)	Price/ Piece ₹
C16/01	20	150	100	960.00
C16/02	20	200	100	1020.00
C16/03	20	300	100	1080.00
C16/04	20	375	100	1110.00
C16/05	20	450	100	1230.00
C16/06	30	250	250	1320.00
C16/07	30	300	250	1380.00
C16/08	30	375	250	1500.00
C16/09	30	450	250	1650.00
C16/10	30	600	250	1800.00
C16/11	30	750	250	2280.00
C16/12	40	375	500	2040.00
C16/13	40	450	500	2370.00
C16/14	40	600	500	2550.00
C16/15	40	750	500	3180.00
C16/16	40	900	500	3300.00
C16/17	65	600	1000	4890.00
C16/18	65	750	1000	6600.00
C16/19	65	900	1000	6870.00

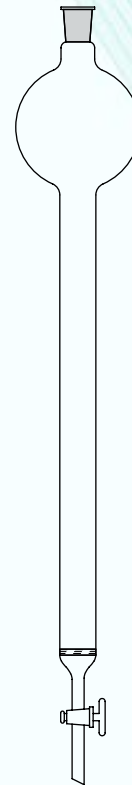

C17- COLUMNS- CHROMATOGRAPHY WITH RESERVOIR

With Straight Bore PTFE Stop- Cock
Sintered Disc With Porosity Grade G0 to G4

Product Code	Size (mm) I.D.	Effective Length	Reservoir Capacity(ml)	Price/ Piece ₹
C17/01	20	150	100	1230.00
C17/02	20	200	100	1290.00
C17/03	20	300	100	1350.00
C17/04	20	375	100	1380.00
C17/05	20	450	100	1500.00
C17/06	30	250	250	1650.00
C17/07	30	300	250	1650.00
C17/08	30	375	250	1740.00
C17/09	30	450	250	1920.00
C17/10	30	600	250	2040.00
C17/11	30	750	250	2460.00
C17/12	40	375	500	2610.00
C17/13	40	450	500	2910.00
C17/14	40	600	500	3280.00
C17/15	40	750	500	3810.00
C17/16	40	900	500	3900.00
C17/17	65	600	1000	5550.00
C17/18	65	750	1000	7200.00
C17/19	65	900	1000	7500.00

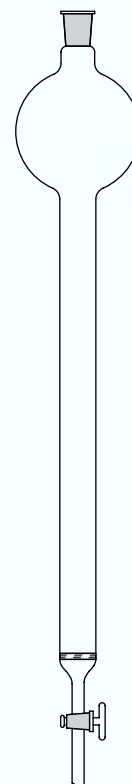

COLUMNS

C18- COLUMNS- CHROMATOGRAPHY

With Ground Joint (Socket) on Top and Straight Bore Glass Stop- Cock/ PTFE Rotaflow Stop- Cock Sintered Disc With Porosity Grade G0 to G4

Product Code	Size (mm) I.D.	Effective Length	Socket Size	Price/ Piece ₹
C18/01	20	150	B-19	840.00
C18/02	20	200	B-19	890.00
C18/03	20	300	B-19	940.00
C18/04	20	375	B-19	960.00
C18/05	20	450	B-24	1060.00
C18/06	30	250	B-24	1080.00
C18/07	30	300	B-24	1110.00
C18/08	30	375	B-24	1140.00
C18/09	30	450	B-24	1320.00
C18/10	30	600	B-24	1440.00
C18/11	30	750	B-24	1800.00
C18/12	40	375	B-34	1680.00
C18/13	40	450	B-34	1950.00
C18/14	40	600	B-34	2100.00
C18/15	40	750	B-34	2640.00
C18/16	40	900	B-34	2730.00
C18/17	65	600	B-34	3000.00
C18/18	65	750	B-34	4380.00
C18/19	65	900	B-34	4560.00



C19- COLUMNS- CHROMATOGRAPHY

With Ground Joint (Socket) on Top and Straight Bore Glass PTFE Stop Cock Sintered Disc With Porosity Grade G0 to G4

Product Code	Size (mm) I.D.	Effective Length	Socket Size	Price/ Piece ₹
C19/01	20	150	B-19	1080.00
C19/02	20	200	B-19	1130.00
C19/03	20	300	B-19	1200.00
C19/04	20	375	B-19	1230.00
C19/05	20	450	B-24	1320.00
C19/06	30	250	B-24	1350.00
C19/07	30	300	B-24	1350.00
C19/08	30	375	B-24	1380.00
C19/09	30	450	B-24	1560.00
C19/10	30	600	B-24	1680.00
C19/11	30	750	B-24	2140.00
C19/12	40	375	B-34	1920.00
C19/13	40	450	B-34	2300.00
C19/14	40	600	B-34	2370.00
C19/15	40	750	B-34	2910.00
C19/16	40	900	B-34	3000.00
C19/17	65	600	B-34	3360.00
C19/18	65	750	B-34	4740.00
C19/19	65	900	B-34	4950.00



COLUMNS

C20- RESERVOIR FLASK FOR CHROMATOGRAPHY COLUMN

With Ground Joint Bottom

Product Code	Capacity (ml)	Ground Joint Size	Quantity Per Case	Price/ Piece ₹
C20/01	100	B-19	5	350.00
C20/02	250	B-19	5	420.00
C20/03	500	B-19	5	510.00
C20/04	250	B-24	5	420.00
C20/05	500	B-24	5	520.00
C20/06	1000	B-24	5	650.00



C21- RESERVOIR FLASK FOR CHROMATOGRAPHY COLUMN

With Long Tube

Product Code	Capacity (ml)	Quantity Per Case	Price/ Piece ₹
C21/01	100	5	250.00
C21/02	250	5	280.00
C21/03	500	5	370.00
C21/04	1000	5	460.00

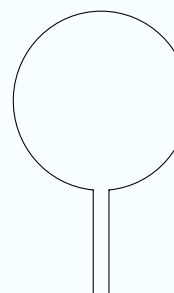

C22- CHROMATOGRAPHY SPRAYER

With Rubber Bellow

Product Code	Capacity (ml)	Quantity Per Case	Price/ Piece ₹
C22/01	50	5	540.00
C22/02	100	5	600.00
C22/03	150	5	700.00
C22/04	250	5	750.00

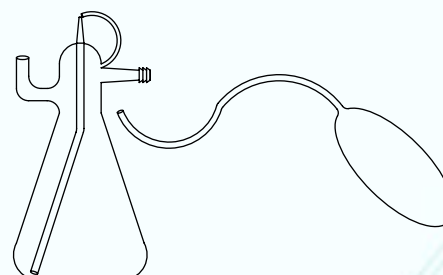

C23- T.L.C. CHAMBER

Tall Form With Flat Flange Cover

Product Code	Size (mm) O.D. x Length	Quantity Per Case	Price/ Piece ₹
C23/01	60 x 80	5	660.00
C23/02	60 x 100	5	690.00
C23/03	60 x 125	5	710.00
C23/04	70 x 125	5	750.00
C23/05	80 x 125	5	810.00

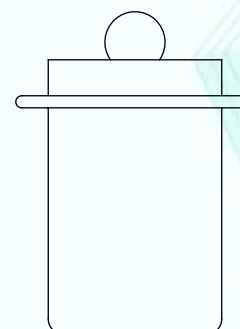

C24- CAPILLARY TUBES FOR TLC

Extra Fine, Machine Made

Product Code	Length (mm)	Quantity Per Case	Price/ Case ₹
C24/01	100	100	1200.00



CONDENSERS

C25- CONDENSERS IMMERSION (COLD FINGER)

Product Code	Cone Size	Effective Length	Quantity Per Case	Price/ Piece ₹
C25/01	B-19	150	5	900.00
C25/02	B-24	150	5	980.00



C26- CONDENSER

Lebig, Interchangeable Inner & Outer Joint

Product Code	Cone/ Socket	Jacket Length	Quantity Per Case	Price/ Piece ₹
C26/01	B-14/14	150	5	340.00
C26/02	B-14/14	200	5	390.00
C26/03	B-14/14	300	5	450.00
C26/04	B-19/19	200	5	450.00
C26/05	B-19/19	300	5	485.00
C26/06	B-24/24	200	5	550.00
C26/07	B-24/24	300	5	600.00
C26/08	B-24/24	450	5	700.00
C26/09	B-24/24	600	5	1100.00
C26/10	B-29/29	300	5	650.00
C26/11	B-29/29	450	5	750.00
C26/12	B-29/29	600	5	1200.00
C26/13	B-34/34	450	5	1350.00
C26/14	B-34/34	600	5	1380.00

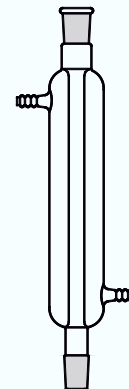

C27- CONDENSER

Allihn, Interchangeable Inner & Outer Joint

Product Code	Cone/ Socket	Jacket Length	Quantity Per Case	Price/ Piece ₹
C27/01	B-19/19	200	5	480.00
C27/02	B-19/19	300	5	525.00
C27/03	B-24/24	200	5	600.00
C27/04	B-24/24	300	5	680.00
C27/05	B-24/24	450	5	950.00
C27/06	B-29/29	300	5	1400.00
C27/07	B-29/29	450	5	1500.00
C27/08	B-34/34	450	5	1800.00
C27/09	B-34/34	600	5	2200.00

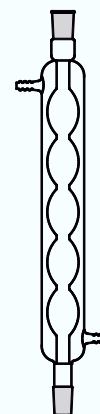

CONDENSERS

C28- CONDENSER

Double Surface

Product Code	Cone/ Socket	Jacket Length	Quantity Per Case	Price/ Piece ₹
C28/01	B-14/14	200	5	750.00
C28/02	B-14/14	300	5	870.00
C28/03	B-19/19	200	5	843.00
C28/04	B-19/19	300	5	1000.00
C28/05	B-24/24	200	5	900.00
C28/06	B-24/24	300	5	1050.00
C28/07	B-24/24	450	5	1850.00
C28/08	B-24/24	600	5	3400.00
C28/09	B-29/29	300	5	1100.00
C28/10	B-29/29	450	5	1450.00
C28/11	B-29/29	600	5	3400.00
C28/12	B-34/34	450	5	2050.00
C28/13	B-34/34	600	5	3500.00

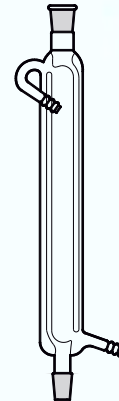

C29- CONDENSER

Single Coil, Interchangeable Inner & Outer Joint

Product Code	Cone/ Socket	Jacket Length	Quantity Per Case	Price/ Piece ₹
C29/01	B-19/19	200	5	540.00
C29/02	B-19/19	300	5	630.00
C29/03	B-24/24	200	5	660.00
C29/04	B-24/24	300	5	810.00
C29/05	B-24/24	450	5	1350.00
C29/06	B-29/29	300	5	990.00
C29/07	B-29/29	450	5	1590.00
C29/08	B-29/29	600	5	2110.00
C29/09	B-34/34	450	5	2070.00
C29/10	B-34/34	600	5	2700.00

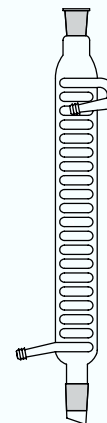

C30- CONDENSER

Jacketed Coil, Interchangeable Inner & Outer Joint

Product Code	Cone/ Socket	Jacket Length	Quantity Per Case	Price/ Piece ₹
C30/01	B-24/24	300	5	1650.00
C30/02	B-24/24	450	5	3200.00
C30/03	B-24/24	600	5	4400.00
C30/04	B-29/29	300	5	1780.00
C30/05	B-29/29	450	5	3350.00
C30/06	B-34/34	450	5	3150.00
C30/07	B-34/34	600	5	4500.00

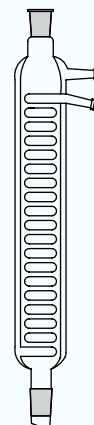

CONDENSERS

C31- CONDENSER

Graham, Coiled Distillation Type, Interchangeable Inner & Outer Joint

Product Code	Cone/ Socket	Jacket Length	Quantity Per Case	Price/ Piece ₹
C31/01	B-14/14	200	5	520.00
C31/02	B-14/14	300	5	650.00
C31/03	B-19/19	300	5	650.00
C31/04	B-24/24	300	5	780.00
C31/05	B-24/24	400	5	830.00

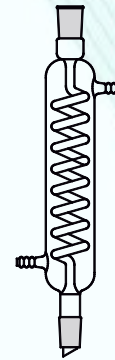

C32- CONDENSER

Double Coil, Interchangeable Inner & Outer Joint

Product Code	Cone/ Socket	Jacket Length	Quantity Per Case	Price/ Piece ₹
C32/01	B-24/24	450	5	5100.00
C32/02	B-24/24	600	5	6500.00
C32/03	B-29/29	450	5	5300.00
C32/04	B-29/29	600	5	6700.00
C32/05	B-34/34	450	5	5800.00
C32/06	B-34/34	600	5	7200.00

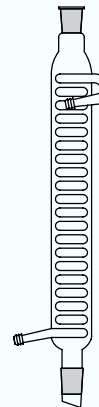

C33- CONDENSER

Fredrichs, Interchangeable Inner & Outer Joint

Product Code	Cone/ Socket	Jacket Length	Quantity Per Case	Price/ Piece ₹
C33/01	B-19/19	150	5	1950.00
C33/02	B-24/24	350	5	4450.00

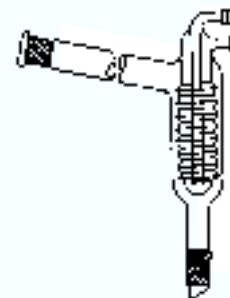

C34- CONDENSER

Ether, Interchangeable Inner & Outer Joint

Product Code	Cone/ Socket	Jacket Length	Quantity Per Case	Price/ Piece ₹
C34/01	B-19/19	180	5	2500.00
C34/02	B-24/24	300	5	2900.00



C35- CONDENSER

Ether, Interchangeable Inner & Outer Joint

Product Code	Cone/ Socket	Jacket Length	Quantity Per Case	Price/ Piece ₹
C35/01	B-19/19	200	5	1700.00
C35/02	B-24/24	200	5	1700.00



CONDENSERS & CYLINDERS

C36- CONDENSER

Vertical, For Water Distillation With Recovery Tube

Product Code	Cone	Jacket Length	Quantity Per Case	Price/ Piece ₹
C36/01	B-24	300	5	3850.00
C36/02	B-24	375	5	4750.00
C36/03	B-34	375	5	4100.00
C36/04	B-34	450	5	5110.00
C36/05	B-55	300	5	5360.00
C36/06	B-55	375	5	6890.00



C37- NESSLER CYLINDERS

Colour Comparison, Graduated, Class A, With Test Certificate

Product Code	Capacity (ml)	Tolerance (±ml)	Quantity Per Case	Price/ Piece ₹
C37/01	50	0.400	5	490.00
C37/02	100	0.800	5	590.00

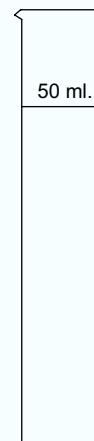

C38- NESSLER CYLINDERS

Colour Comparison, Graduated, Class B, With Test Certificate

Product Code	Capacity (ml)	Size O.D. X Height (mm)	Quantity Per Case	Price/ Piece ₹
C38/01	50	26 x 150	5	150.00
C38/02	100	34 x 180	5	225.00

C39- CYLINDERS

Measuring Cylinders, With I/C Stopper, Round Base, Class A, With Test Certificate.

Product Code	Capacity (ml)	Interval (ml)	Tolerance (±ml)	Stopper Size	Quantity Per Case	Price/ Piece ₹
C39/01	5	0.1	0.05	B-10	5	390.00
C39/02	10	0.2	0.10	B-10	5	415.00
C39/03	25	0.5	0.25	B-14	5	450.00
C39/04	50	1.0	0.50	B-14	5	500.00
C39/05	100	1.0	0.50	B-19	5	640.00
C39/06	250	2.0	1.00	B-24	5	1200.00
C39/07	500	5.0	2.50	B-24	5	1360.00
C39/08	1000	10.0	5.00	B-34	5	1800.00
C39/09	2000	20.0	10.0	B-34	5	3800.00

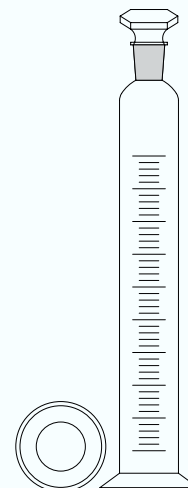

CYLINDERS

C40- CYLINDERS

Measuring Cylinders, With I/C Stopper, Round Base, Class B

Product Code	Capacity (ml)	Interval (ml)	Tolerance (±ml)	Stopper Size	Quantity Per Case	Price/ Piece ₹
C40/01	5	0.1	0.10	B-10	5	240.00
C40/02	10	0.2	0.20	B-10	5	250.00
C40/03	25	0.5	0.50	B-14	5	360.00
C40/04	50	1.0	1.00	B-14	5	415.00
C40/05	100	1.0	1.00	B-19	5	520.00
C40/06	250	2.0	2.00	B-24	5	900.00
C40/07	500	5.0	5.00	B-24	5	1200.00
C40/08	1000	10.0	10.0	B-34	5	1680.00
C40/09	2000	20.0	20.0	B-34	5	2700.00

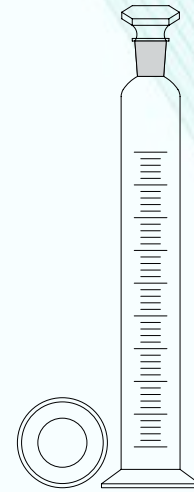

C41- CYLINDERS

Measuring Cylinders, With Pour Out, Round Base, Class A, With Test Certificate

Product Code	Capacity (ml)	Graduation Interval (±ml)	Tolerance (±ml)	Price/ Piece ₹
C41/01	5	0.10	0.05	240.00
C41/02	10	0.20	0.10	260.00
C41/03	25	0.50	0.25	300.00
C41/04	50	1.00	0.50	375.00
C41/05	100	1.00	0.50	480.00
C41/06	250	2.00	1.00	840.00
C41/07	500	5.00	2.50	1200.00
C41/08	1000	10.0	5.00	1560.00
C41/09	2000	20.0	10.0	3000.00



C42- CYLINDERS

Measuring Cylinders, With Pour Out, Round Base, Class B

Product Code	Capacity (ml)	Graduation Interval (±ml)	Tolerance (±ml)	Price/ Piece ₹
C42/01	5	0.10	0.10	110.00
C42/02	10	0.20	0.20	160.00
C42/03	25	0.50	0.50	200.00
C42/04	50	1.00	1.00	250.00
C42/05	100	1.00	1.00	300.00
C42/06	250	2.00	2.00	550.00
C42/07	500	5.00	5.00	840.00
C42/08	1000	10.0	10.0	1150.00
C42/09	2000	20.0	20.0	2000.00

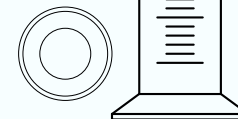

CYLINDERS

C43- CYLINDERS

Measuring Cylinders, With Pour Out, Hexagonal Base, Class A, With Test Certificate

Product Code	Capacity (ml)	Graduation Interval (\pm ml)	Tolerance (\pm ml)	Price/ Piece ₹
C43/01	5	0.10	0.05	360.00
C43/02	10	0.20	0.10	450.00
C43/03	25	0.50	0.25	550.00
C43/04	50	1.00	0.50	600.00
C43/05	100	1.00	0.50	700.00
C43/06	250	2.00	1.00	1000.00
C43/07	500	5.00	2.50	1400.00
C43/08	1000	10.0	5.00	1900.00
C43/09	2000	20.0	10.0	3600.00

C44- CYLINDERS

Measuring Cylinders, With Pour Out, Hexagonal Base, Class B

Product Code	Capacity (ml)	Graduation Interval (\pm ml)	Tolerance (\pm ml)	Price/ Piece ₹
C44/01	5	0.10	0.10	210.00
C44/02	10	0.20	0.20	240.00
C44/03	25	0.50	0.50	270.00
C44/04	50	1.00	1.00	330.00
C44/05	100	1.00	1.00	370.00
C44/06	250	2.00	2.00	690.00
C44/07	500	5.00	5.00	990.00
C44/08	1000	10.0	10.0	1440.00
C44/09	2000	20.0	20.0	2610.00

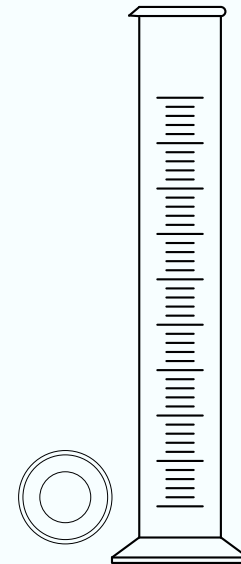

C45- CYLINDERS

Crow Receiver, With Pour Out, Round Base

Product Code	Capacity (ml)	Quantity Per Case	Price/ Piece ₹
C45/01	25	5	370.00
C45/02	50	5	450.00
C45/03	100	5	600.00

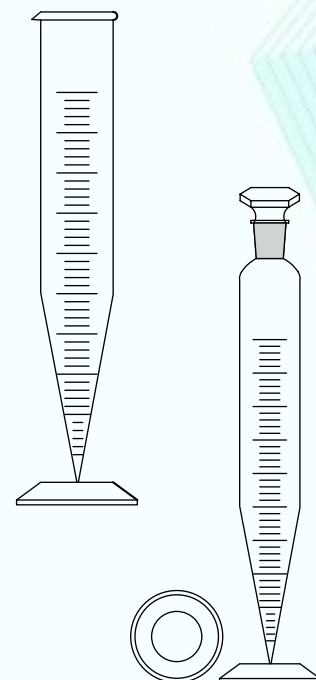

C46- CYLINDERS

Crow Receiver, With I/C. Stopper, Round Base

Product Code	Capacity (ml)	Quantity Per Case	Price/ Piece ₹
C46/01	25	5	470.00
C46/02	50	5	550.00
C46/03	100	5	750.00

DEAN & STARK RECEIVERS

D01- DEAN & STARK

For Moisture Estimation, With Stop- Cock

Product Code	Cone/Socket	Cap. (ml)	Quantity Per Case	Price/ Piece ₹
D01/01	B-14/14	5	5	1250.00
D01/02	B-19/19	5	5	1250.00
D01/03	B-19/19	10	5	1300.00
D01/04	B-24/24	10	5	1350.00
D01/05	B-24/24	25	5	1300.00
D01/06	B-29/29	25	5	1300.00
D01/07	B-29/29	50	5	1400.00
D01/08	B-34/34	25	5	1300.00
D01/09	B-34/34	50	5	1400.00

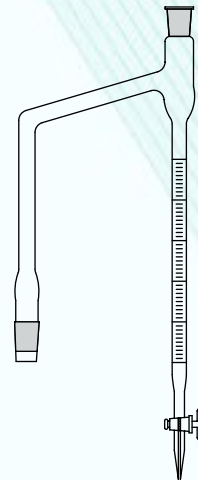

D02- RECEIVERS

For Estimation of Volatile Oils Lighter Than Water (Clevenger Type)

Product Code	Cone/Socket	Cap. (ml)	Quantity Per Case	Price/ Piece ₹
D02/01	B-14/14	5	5	1650.00
D02/02	B-19/19	5	5	1650.00
D02/03	B-19/19	10	5	1700.00
D02/04	B-24/24	10	5	1750.00
D02/05	B-24/24	25	5	1700.00
D02/06	B-29/29	25	5	1700.00
D02/07	B-29/29	50	5	1800.00
D02/08	B-34/34	25	5	1700.00
D02/09	B-34/34	50	5	1800.00

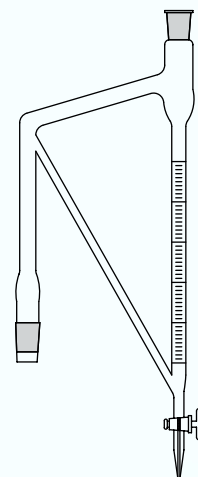

D03- RECEIVERS

For Estimation of Volatile Oils Heavier Than Water (Clevenger Type)

Product Code	Cone/Socket	Cap. (ml)	Quantity Per Case	Price/ Piece ₹
D03/01	B-14/14	5	5	1650.00
D03/02	B-19/19	5	5	1650.00
D03/03	B-19/19	10	5	1700.00
D03/04	B-24/24	10	5	1750.00
D03/05	B-24/24	25	5	1700.00
D03/06	B-29/29	25	5	1700.00
D03/07	B-29/29	50	5	1800.00
D03/08	B-34/34	25	5	1700.00
D03/09	B-34/34	50	5	1800.00

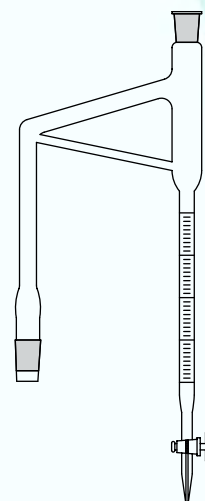

DESICCATORS & DISHES

D04- DESICCATORS

With Cover and Porcelain Plate

Product Code	Approx ID Ground Flange	Quantity Per Case	Price/ Piece ₹
D04/01	100	1	1500.00
D04/02	150	1	2000.00
D04/03	200	1	3200.00
D04/04	250	1	4500.00
D04/05	300	1	7800.00

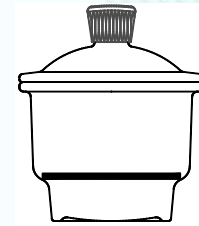

D05- VACUUM DESICCATORS

Vacuum, Stopcock With PTFE Spindle and Porcelain Plate

Product Code	Approx ID Ground Flange	Quantity Per Case	Price/ Piece ₹
D05/01	150	1	2200.00
D05/02	200	1	4300.00
D05/03	250	1	6000.00
D05/04	300	1	9900.00

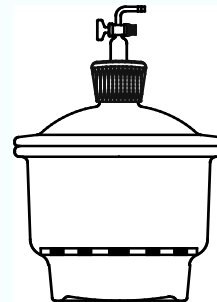

D06- DISHES

Crystallizing

Product Code	Approx. O.D. x Height	Approx. Capacity (ml)	Quantity Per Case	Price/ Piece ₹
D06/01	100 x 50	300	10	490.00
D06/02	150 x 75	1000	10	990.00
D06/03	190 x 100	2000	5	1600.00

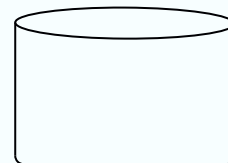

D07- DISHES

Culture, Petri

Product Code	Approx. O.D. x Height	Quantity Per Case	Price/ Piece ₹
D07/01	50 x 17	100	160.00
D07/02	80 x 17	100	180.00
D07/03	100 x 17	100	190.00
D07/04	100 x 20	40	230.00
D07/05	150 x 20	10	575.00
D07/06	200 x 20	10	1100.00

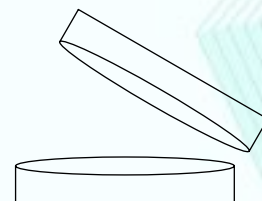

D08- DISHES

Evaporating, Flat Bottom, With Pour Out

Product Code	Approx. O.D. x Height	Quantity Per Case	Price/ Piece ₹
D08/01	80 x 45	10	350.00
D08/02	105 x 55	10	500.00
D08/03	150 x 80	10	900.00
D08/04	200 x 100	8	1900.00

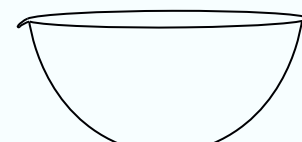

DISTILLING APPARATUS

D09- DISTILLING APPARATUS

Ammonia, With Graham Condenser, Interchangeable Joints

Product Code	Capacity (ml)	Quantity Per Case	Price/ Piece ₹
D09/01	500	1	2080.00
D09/02	800	1	2470.00

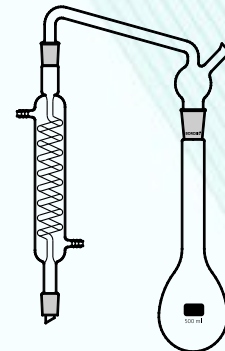

D10- DISTILLING APPARATUS

With Graham Condenser, Interchangeable Joints & Stopper

Product Code	Capacity (ml)	Condenser Jacket	Interchangeable Joint	Quantity Per Case	Price/ Piece ₹
A10/01	500	200	B-19	1	1560.00
A10/02	1000	400	B-24	1	2340.00

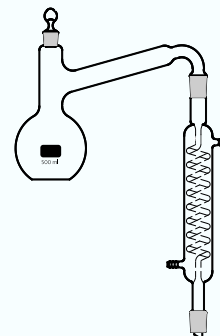

D11- DISTILLING APPARATUS

With Friedrichs Condenser, Interchangeable Joints & Stopper

Product Code	Capacity (ml)	Condenser Jacket	Interchangeable Joint	Quantity Per Case	Price/ Piece ₹
D11/01	1000	350	B-24	1	3900.00
D11/02	2000	400	B-29	1	4400.00

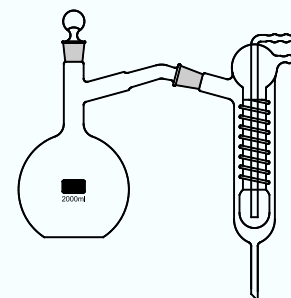

D12- DISTILLING APPARATUS

Compact With Friedrichs Condenser, Interchangeable Joints

Product Code	Capacity (ml)	Condenser Jacket	Interchangeable Joint	Quantity Per Case	Price/ Piece ₹
D12/01	1000	495	B-34	1	3500.00
D12/02	2000	525	B-39	1	4300.00

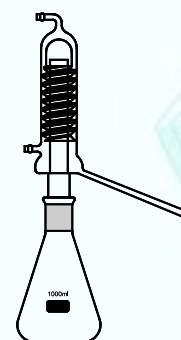

D13- ESSENTIAL OIL DETERMINATION APPARATUS

For Oil Heavier Than Water

Product Code	Capacity (ml)	Quantity Per Case	Price/ Piece ₹
D13/01	1000	1	3000.00

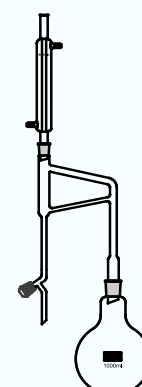

DISTILLING APPARATUS

D14- ESSENTIAL OIL DETERMINATION APPARATUS

For Oil Lighter Than Water

Product Code	Capacity (ml)	Quantity Per Case	Price/ Piece ₹
D14/01	1000	1	3000.00

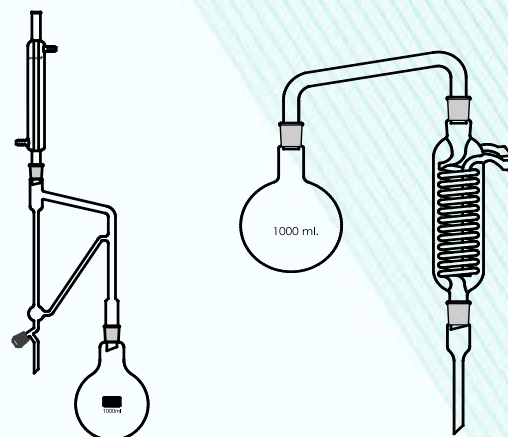

D15- ALCOHOL DISTILLATION UNIT

With Thoreps Revenue Condenser

Product Code	Capacity (ml)	Quantity Per Case	Price/ Piece ₹
D15/01	1000	1	5100.00
D15/02	2000	1	7800.00

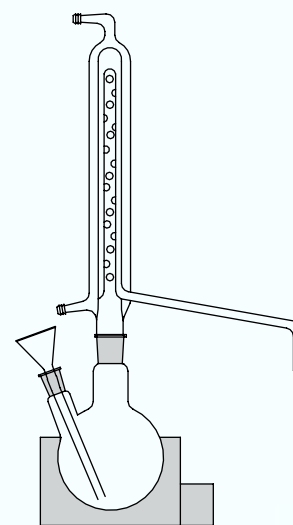

D16- WATER DISTILLATION UNIT

With Thoreps Revenue Condenser

Product Code	Capacity (ml)	Quantity Per Case	Price/ Piece ₹
D16/01	2000	1	11900.00
D16/02	3000	1	12400.00
D16/03	5000	1	14200.00
D16/04	10000	1	18900.00
D16/05	20000	1	28700.00

D17- DISTILLING APPARATUS

With Friedrichs Condenser, Interchangeable Joints & Stopper

Product Code	Receiver Cone	Condenser Type	Jacket Length	Quantity Per Case	Price/ Piece ₹
D17/01	B-14	Lebig	200	1	1200.00
D17/02	B-14	Double Surface	200	1	1850.00
D17/03	B-19	Lebig	300	1	1500.00
D17/04	B-19	Double Surface	300	1	2300.00
D17/05	B-24	Lebig	300	1	1700.00
D17/06	B-24	Double Surface	300	1	2600.00

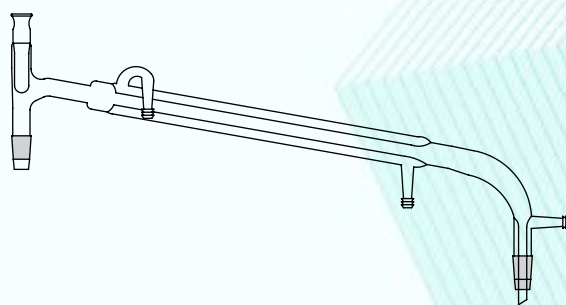

D18- DISTILLING APPARATUS

With Friedrichs Condenser, Interchangeable Joints & Stopper

Product Code	Receiver Flask Cap.	Vigreux Length	Condenser Type	Jacket Length	Price/ Piece ₹
D18/01	B-14	150	Double Surface	1	2600.00
D18/02	B-14	200	Double Surface	1	3200.00
D18/03	B-19	200	Double Surface	1	3500.00
D18/04	B-19	300	Double Surface	1	4100.00
D18/05	B-24	200	Double Surface	1	3800.00
D18/06	B-24	300	Double Surface	1	4700.00

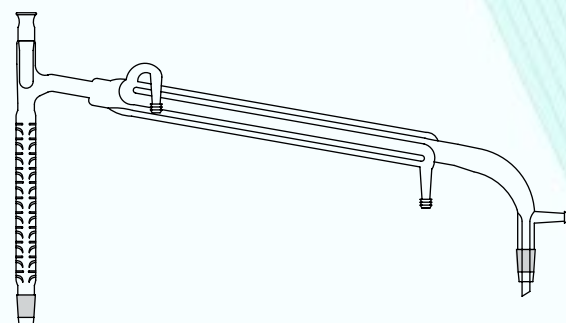

EXTRACTORS

E01- EXTRACTORS

Soxhlet, Interchangeable Joint

Product Code	Capacity (ml)	Interchangeable Joints		Quantity Per Case	Price/ Piece ₹
		Socket	Cone		
E01/01	60	B-34	B-24	5	1150.00
E01/02	100	B-40	B-24	5	1150.00
E01/03	200	B-50	B-24	5	1150.00
E01/04	500	B-55	B-34	5	2050.00
E01/05	1000	B-55	B-34	5	3100.00
E01/06	2000	B-55	B-34	5	7200.00

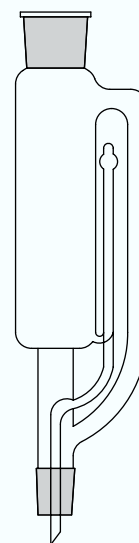
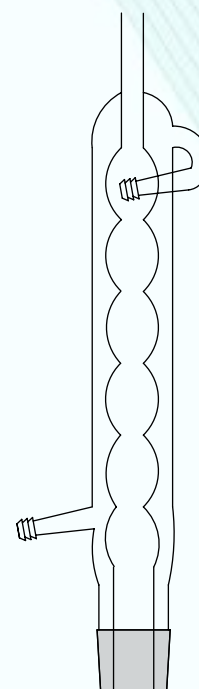
E01

E02

E02- CONDENSERS, ALLIHN

For Soxhlet Extraction Apparatus

Product Code	Capacity (ml)	Interchangeable Joint	Quantity Per Case	Price/ Piece ₹
E02/01	60	B-34	5	1100.00
E02/02	100	B-40	5	1200.00
E02/03	200	B-50	5	1400.00
E02/04	500	B-55	5	1800.00
E02/05	1000	B-55	5	2220.00
E02/06	2000	B-55	5	2520.00

E03- EXTRACTION APPARATUS

Soxhlet Complete With Allihn Condenser Interchangeable Joint

Product Code	Capacity (ml)	Flask Size (ml)	Quantity Per Case	Price/ Piece ₹
E03/01	60	150	1	2495.00
E03/02	100	250	1	2725.00
E03/03	200	500	1	3550.00
E03/04	500	2000	1	4800.00
E03/05	1000	3000	1	7800.00
E03/06	2000	5000	1	16800.00

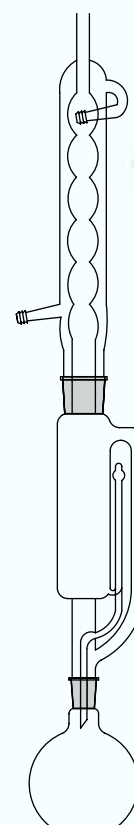

FLASKS

F01- FLASKS

Boiling, Flat Bottom, Plain Neck

Product Code	Capacity (ml)	Quantity Per Case	Price/ Piece ₹
F01/01	25	5	70.00
F01/02	50	5	80.00
F01/03	100	5	100.00
F01/04	150	5	110.00
F01/05	250	5	140.00
F01/06	500	5	230.00
F01/07	1000	5	395.00
F01/08	2000	5	1100.00
F01/09	3000	5	1900.00
F01/10	5000	5	3200.00
F01/11	10000	5	6800.00
F01/12	20000	5	12500.00



F02- FLASKS

Boiling, Flat Bottom, Short Neck, Interchangeable Joint

Product Code	Capacity (ml)	Interchangeable Joint	Quantity Per Case	Price/ Piece ₹
F02/01	150	B-24	5	200.00
F02/02	250	B-24	5	230.00
F02/03	500	B-24	5	270.00
F02/04	1000	B-34	5	480.00
F02/05	2000	B-34	5	1300.00
F02/06	3000	B-34	5	2600.00
F02/07	5000	B-34	5	4000.00

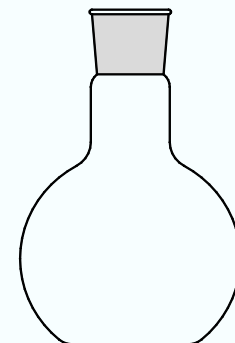

F03- FLASKS

Boiling, Round Bottom, Plain Neck

Product Code	Capacity (ml)	Quantity Per Case	Price/ Piece ₹
F03/01	25	5	70.00
F03/02	50	5	80.00
F03/03	100	5	100.00
F03/04	150	5	110.00
F03/05	250	5	140.00
F03/06	500	5	230.00
F03/07	1000	5	380.00
F03/08	2000	5	1030.00
F03/09	3000	5	1850.00
F03/10	5000	5	3100.00
F03/11	10000	5	6600.00
F03/12	20000	5	12000.00

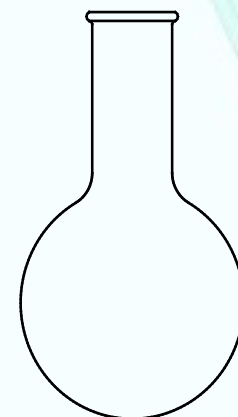

FLASKS

F04- FLASKS

Boiling, Pear Shaped, Short Neck, With Interchangeable Joint

Product Code	Capacity (ml)	Interchangeable Joint	Quantity Per Case	Price/ Piece ₹
F04/01	10	B-14	5	150.00
F04/02	25	B-14	5	180.00
F04/03	50	B-14	5	220.00
F04/04	100	B-24	5	290.00



F05- FLASKS

Boiling, Rotavapour, with Interchangeable Joint

Product Code	Capacity (ml)	Interchangeable Joint	Quantity Per Case	Price/ Piece ₹
F05/01	25	B-14	5	350.00
F05/02	50	B-14	5	370.00
F05/03	100	B-29	5	540.00
F05/04	250	B-29	5	720.00
F05/05	500	B-29	5	900.00
F05/06	1000	B-29	5	1700.00
F05/07	2000	B-29	5	3000.00
F05/08	3000	B-29	5	4400.00

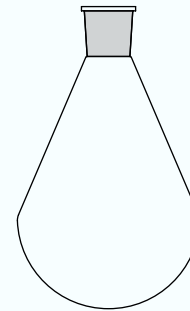

F06- FLASKS

Reaction Vessel, Wide Mouth, With Flat Flange

Product Code	Capacity (ml)	Quantity Per Case	Price/ Piece ₹
F06/01	1000	5	1800.00
F06/02	2000	5	2600.00
F06/03	3000	5	4400.00
F06/04	5000	5	6000.00
F06/05	10000	5	12000.00
F06/06	20000	5	18500.00

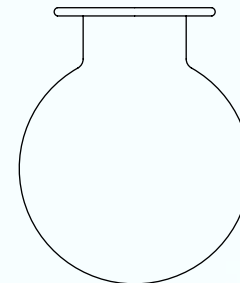

F07- LIDS

For Reaction Vessel, 100mm I.D., 150mm O.D.

Product Code	No. of Necks	Quantity Per Case	Price/ Piece ₹
F07/01	One	5	2700.00
F07/02	Two	5	3300.00
F07/03	Three	5	3600.00
F07/04	Four	5	4200.00
F07/05	Five	5	4800.00

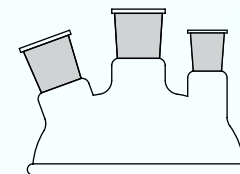

F08- SS WIRE CLIPS

For Reaction Vessel, 100mm I.D., 150mm O.D.

Product Code	Size (mm)	Quantity Per Case	Price/ Piece ₹
F08/01	100 X 150	5	990.00

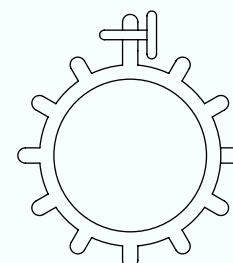

FLASKS

F09- ROUND BOTTOM FLASK

Round Bottom, Single Neck, Short Neck With I/C Joint

Product Code	Capacity (ml)	Interchangeable Joint	Quantity Per Case	Price/ Piece ₹
F09/01	5	B-14	5	70.00
F09/02	10	B-14	5	80.00
F09/03	10	B-19	5	80.00
F09/04	25	B-14	5	100.00
F09/05	25	B-19	5	100.00
F09/06	50	B-14	5	120.00
F09/07	50	B-19	5	120.00
F09/08	50	B-24	5	125.00
F09/09	100	B-14	5	180.00
F09/10	100	B-19	5	180.00
F09/11	100	B-24	5	180.00
F09/12	150	B-14	5	195.00
F09/13	150	B-19	5	195.00
F09/14	150	B-24	5	200.00
F09/15	250	B-19	5	230.00
F09/16	250	B-24	5	230.00
F09/17	250	B-29	5	240.00
F09/18	250	B-34	5	240.00
F09/19	500	B-19	5	270.00
F09/20	500	B-24	5	270.00
F09/21	500	B-29	5	290.00
F09/22	500	B-34	5	290.00
F09/23	1000	B-19	5	450.00
F09/24	1000	B-24	5	450.00
F09/25	1000	B-29	5	480.00
F09/26	1000	B-34	5	480.00
F09/27	2000	B-24	5	1300.00
F09/28	2000	B-29	5	1300.00
F09/29	2000	B-34	5	1300.00
F09/30	3000	B-24	5	2580.00
F09/31	3000	B-29	5	2580.00
F09/32	3000	B-34	5	2600.00
F09/33	5000	B-24	5	4000.00
F09/34	5000	B-29	5	4000.00
F09/35	5000	B-34	5	4000.00
F09/36	5000	B-55	5	4000.00
F09/37	10000	B-24	5	7500.00
F09/38	10000	B-29	5	7500.00
F09/39	10000	B-34	5	7500.00
F09/40	10000	B-55	5	7500.00
F09/41	20000	B-24	5	13000.00
F09/42	20000	B-29	5	13000.00
F09/43	20000	B-34	5	13000.00
F09/44	20000	B-55	5	13000.00

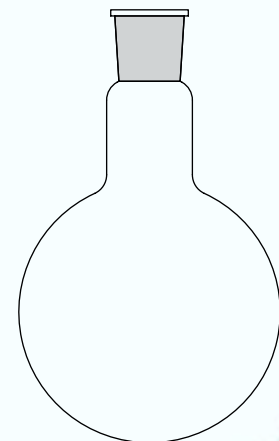

FLASKS

F10- ROUND BOTTOM FLASK

Round Bottom, Two Necks, Centre Neck & One Angled Neck

Product Code	Capacity (ml)	Interchangeable Joints		Quantity Per Case	Price/ Piece ₹
		Centre	Side		
F10/01	10	B-19	B-14	5	130.00
F10/02	25	B-19	B-14	5	150.00
F10/03	50	B-19	B-14	5	170.00
F10/04	100	B-24	B-14	5	280.00
F10/05	100	B-24	B-19	5	280.00
F10/06	100	B-29	B-19	5	290.00
F10/07	150	B-24	B-14	5	340.00
F10/08	150	B-24	B-19	5	340.00
F10/09	150	B-29	B-19	5	340.00
F10/10	250	B-24	B-14	5	400.00
F10/11	250	B-24	B-19	5	400.00
F10/12	250	B-24	B-24	5	400.00
F10/13	250	B-29	B-19	5	400.00
F10/14	500	B-24	B-14	5	520.00
F10/15	500	B-24	B-19	5	520.00
F10/16	500	B-24	B-24	5	520.00
F10/17	500	B-29	B-19	5	520.00
F10/18	1000	B-24	B-19	5	660.00
F10/19	1000	B-29	B-19	5	660.00
F10/20	1000	B-24	B-24	5	660.00
F10/21	1000	B-34	B-24	5	660.00
F10/22	2000	B-24	B-19	5	1500.00
F10/23	2000	B-29	B-19	5	1500.00
F10/24	2000	B-24	B-24	5	1500.00
F10/25	2000	B-29	B-24	5	1500.00
F10/26	2000	B-34	B-24	5	1500.00
F10/27	3000	B-24	B-19	5	3200.00
F10/28	3000	B-24	B-24	5	3200.00
F10/29	3000	B-29	B-19	5	3200.00
F10/30	3000	B-34	B-24	5	3200.00
F10/31	3000	B-34	B-19	5	3200.00
F10/32	5000	B-24	B-19	5	4800.00
F10/33	5000	B-29	B-19	5	4800.00
F10/34	5000	B-24	B-24	5	4800.00
F10/35	5000	B-34	B-24	5	4800.00
F10/36	5000	B-34	B-19	5	4800.00
F10/37	10000	B-24	B-19	5	8500.00
F10/38	10000	B-29	B-19	5	8500.00
F10/39	10000	B-24	B-24	5	8500.00
F10/40	10000	B-34	B-29	5	8500.00
F10/41	10000	B-55	B-24	5	8500.00
F10/42	20000	B-24	B-19	5	15000.00
F10/43	20000	B-24	B-24	5	15000.00
F10/44	20000	B-29	B-19	5	15000.00
F10/45	20000	B-34	B-24	5	15000.00
F10/46	20000	B-55	B-24	5	15000.00

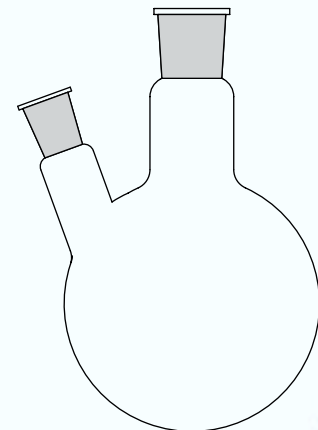

FLASKS

F11- ROUND BOTTOM FLASK

Round Bottom, Two Necks, Centre Neck & One Parallel Neck

Product Code	Capacity (ml)	Interchangeable Joints		Quantity Per Case	Price/ Piece ₹
		Centre	Side		
F11/01	10	B-19	B-14	5	130.00
F11/02	25	B-19	B-14	5	150.00
F11/03	50	B-19	B-14	5	170.00
F11/04	100	B-24	B-14	5	280.00
F11/05	100	B-24	B-19	5	280.00
F11/06	100	B-29	B-19	5	290.00
F11/07	150	B-24	B-14	5	340.00
F11/08	150	B-24	B-19	5	340.00
F11/09	150	B-29	B-19	5	340.00
F11/10	250	B-24	B-14	5	400.00
F11/11	250	B-24	B-19	5	400.00
F11/12	250	B-24	B-24	5	400.00
F11/13	250	B-29	B-19	5	400.00
F11/14	500	B-24	B-14	5	520.00
F11/15	500	B-24	B-19	5	520.00
F11/16	500	B-24	B-24	5	520.00
F11/17	500	B-29	B-19	5	520.00
F11/18	1000	B-24	B-19	5	660.00
F11/19	1000	B-29	B-19	5	660.00
F11/20	1000	B-24	B-24	5	660.00
F11/21	1000	B-34	B-24	5	660.00
F11/22	2000	B-24	B-19	5	1500.00
F11/23	2000	B-29	B-19	5	1500.00
F11/24	2000	B-24	B-24	5	1500.00
F11/25	2000	B-29	B-24	5	1500.00
F11/26	2000	B-34	B-24	5	1500.00
F11/27	3000	B-24	B-19	5	3200.00
F11/28	3000	B-24	B-24	5	3200.00
F11/29	3000	B-29	B-19	5	3200.00
F11/30	3000	B-34	B-24	5	3200.00
F11/31	3000	B-34	B-19	5	3200.00
F11/32	5000	B-24	B-19	5	4800.00
F11/33	5000	B-29	B-19	5	4800.00
F11/34	5000	B-24	B-24	5	4800.00
F11/35	5000	B-34	B-24	5	4800.00
F11/36	5000	B-34	B-19	5	4800.00
F11/37	10000	B-24	B-19	5	8500.00
F11/38	10000	B-29	B-19	5	8500.00
F11/39	10000	B-24	B-24	5	8500.00
F11/40	10000	B-34	B-29	5	8500.00
F11/41	10000	B-55	B-24	5	8500.00
F11/42	20000	B-24	B-19	5	15000.00
F11/43	20000	B-24	B-24	5	15000.00
F11/44	20000	B-29	B-19	5	15000.00
F11/45	20000	B-34	B-24	5	15000.00
F11/46	20000	B-55	B-24	5	15000.00

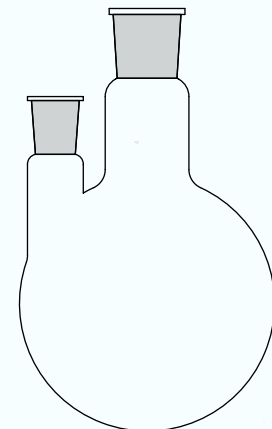

FLASKS

F12- ROUND BOTTOM FLASK

Round Bottom, Three Necks, Centre Neck & Two Angle Neck

Product Code	Capacity (ml)	Interchangeable Joints		Quantity Per Case	Price/ Piece ₹
		Centre	Side		
F12/01	100	B-19	B-14/14	5	360.00
F12/02	100	B-19	B-19/19	5	360.00
F12/03	100	B-24	B-19/19	5	360.00
F12/04	150	B-24	B-19/19	5	450.00
F12/05	150	B-24	B-19/14	5	450.00
F12/06	250	B-24	B-19/19	5	490.00
F12/07	250	B-24	B-19/14	5	490.00
F12/08	250	B-24	B-24/19	5	490.00
F12/09	250	B-24	B-24/24	5	490.00
F12/10	250	B-19	B-19/19	5	490.00
F12/11	500	B-24	B-19/19	5	660.00
F12/12	500	B-24	B-24/19	5	710.00
F12/13	500	B-24	B-24/24	5	710.00
F12/14	500	B-19	B-19/19	5	710.00
F12/15	500	B-24	B-19/14	5	710.00
F12/16	1000	B-24	B-24/24	5	960.00
F12/17	1000	B-29	B-24/19	5	960.00
F12/18	1000	B-34	B-24/24	5	960.00
F12/19	2000	B-24	B-24/14	5	1850.00
F12/20	2000	B-24	B-24/19	5	1850.00
F12/21	2000	B-29	B-24/19	5	1850.00
F12/22	2000	B-34	B-24/19	5	1850.00
F12/23	2000	B-24	B-24/24	5	1850.00
F12/24	2000	B-34	B-24/24	5	1850.00
F12/25	3000	B-24	B-19/19	5	4200.00
F12/26	3000	B-24	B-24/19	5	4200.00
F12/27	3000	B-29	B-24/19	5	4200.00
F12/28	3000	B-34	B-24/19	5	4200.00
F12/29	3000	B-24	B-24/24	5	4200.00
F12/30	3000	B-34	B-24/24	5	4200.00
F12/31	5000	B-34	B-24/24	5	6000.00
F12/32	5000	B-24	B-24/24	5	6000.00
F12/33	5000	B-29	B-24/24	5	6000.00
F12/34	5000	B-34	B-34/34	5	6000.00
F12/35	10000	B-24	B-24/24	5	11000.00
F12/36	10000	B-34	B-24/24	5	11000.00
F12/37	10000	B-29	B-24/24	5	11000.00
F12/38	10000	B-55	B-24/24	5	11000.00
F12/39	10000	B-55	B-34/24	5	11000.00
F12/40	20000	B-34	B-19/19	5	18000.00
F12/41	20000	B-24	B-24/24	5	18000.00
F12/42	20000	B-34	B-24/24	5	18000.00
F12/43	20000	B-34	B-34/34	5	18000.00
F12/44	20000	B-55	B-34/34	5	18000.00

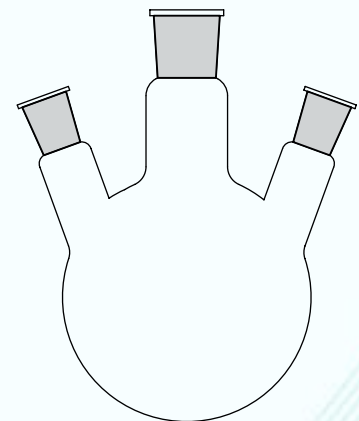

FLASKS

F13- ROUND BOTTOM FLASK

Round Bottom, Three Necks, Centre Neck & Two Parallel Neck

Product Code	Capacity (ml)	Interchangeable Joints		Quantity Per Case	Price/ Piece ₹
		Centre	Side		
F13/01	100	B-19	B-14/14	5	360.00
F13/02	100	B-19	B-19/19	5	360.00
F13/03	100	B-24	B-19/19	5	360.00
F13/04	150	B-24	B-19/19	5	450.00
F13/05	150	B-24	B-19/14	5	450.00
F13/06	250	B-24	B-19/19	5	490.00
F13/07	250	B-24	B-19/14	5	490.00
F13/08	250	B-24	B-24/19	5	490.00
F13/09	250	B-24	B-24/24	5	490.00
F13/10	250	B-19	B-19/19	5	490.00
F13/11	500	B-24	B-19/19	5	690.00
F13/12	500	B-24	B-24/19	5	710.00
F13/13	500	B-24	B-24/24	5	710.00
F13/14	500	B-19	B-19/19	5	710.00
F13/15	500	B-24	B-19/14	5	710.00
F13/16	1000	B-24	B-24/24	5	960.00
F13/17	1000	B-29	B-24/19	5	960.00
F13/18	1000	B-34	B-24/24	5	960.00
F13/19	2000	B-24	B-24/14	5	1850.00
F13/20	2000	B-24	B-24/19	5	1850.00
F13/21	2000	B-29	B-24/19	5	1850.00
F13/22	2000	B-34	B-24/19	5	1850.00
F13/23	2000	B-24	B-24/24	5	1850.00
F13/24	2000	B-34	B-24/24	5	1850.00
F13/25	3000	B-24	B-19/19	5	4200.00
F13/26	3000	B-24	B-24/19	5	4200.00
F13/27	3000	B-29	B-24/19	5	4200.00
F13/28	3000	B-34	B-24/19	5	4200.00
F13/29	3000	B-24	B-24/24	5	4200.00
F13/30	3000	B-34	B-24/24	5	4200.00
F13/31	5000	B-34	B-24/24	5	6000.00
F13/32	5000	B-24	B-24/24	5	6000.00
F13/33	5000	B-29	B-24/24	5	6000.00
F13/34	5000	B-34	B-34/34	5	6000.00
F13/35	10000	B-24	B-24/24	5	11000.00
F13/36	10000	B-34	B-24/24	5	11000.00
F13/37	10000	B-29	B-24/24	5	11000.00
F13/38	10000	B-55	B-24/24	5	11000.00
F13/39	10000	B-55	B-34/24	5	11000.00
F13/40	20000	B-34	B-19/19	5	18000.00
F13/41	20000	B-24	B-24/24	5	18000.00
F13/42	20000	B-34	B-24/24	5	18000.00
F13/43	20000	B-34	B-34/34	5	18000.00
F13/44	20000	B-55	B-34/34	5	18000.00

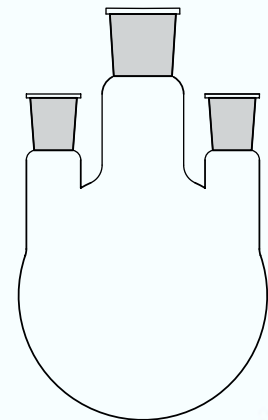

FLASKS

F14- ROUND BOTTOM FLASK

Round Bottom, Four Necks, Centre Neck & Three Angle Neck

Product Code	Capacity (ml)	Interchangeable Joints		Quantity Per Case	Price/ Piece ₹
		Centre	Side		
F14/01	250	B-24	B-14/14/14	5	750.00
F14/02	500	B-34	B-24/24/24	5	1000.00
F14/03	1000	B-34	B-24/24/24	5	1400.00
F14/04	1000	B-34	B-34/24/24	5	1400.00
F14/05	2000	B-34	B-24/24/24	5	2300.00
F14/06	2000	B-34	B-34/24/24	5	2300.00
F14/07	3000	B-34	B-24/24/24	5	4600.00
F14/08	3000	B-34	B-34/24/24	5	4600.00
F14/09	5000	B-34	B-24/24/24	5	6000.00
F14/10	5000	B-34	B-34/24/24	5	6000.00
F14/11	10000	B-34	B-24/24/24	5	12000.00
F14/12	10000	B-55	B-34/24/24	5	12000.00
F14/13	20000	B-55	B-34/24/24	5	18000.00

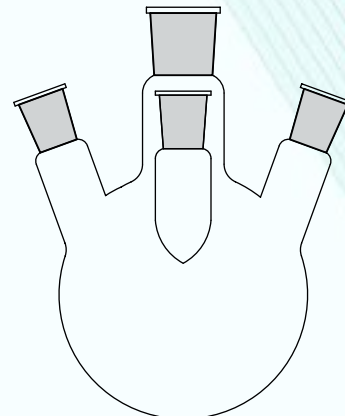

F15- ROUND BOTTOM FLASK

Round Bottom, Four Necks, Centre Neck & Three Parallel Neck

Product Code	Capacity (ml)	Interchangeable Joints		Quantity Per Case	Price/ Piece ₹
		Centre	Side		
F15/01	250	B-24	B-14/14/14	5	700.00
F15/02	500	B-34	B-24/24/24	5	1100.00
F15/03	1000	B-34	B-24/24/24	5	1400.00
F15/04	1000	B-34	B-34/24/24	5	1400.00
F15/05	2000	B-34	B-24/24/24	5	2300.00
F15/06	2000	B-34	B-34/24/24	5	2300.00
F15/07	3000	B-34	B-24/24/24	5	4700.00
F15/08	3000	B-34	B-34/24/24	5	4700.00
F15/09	5000	B-34	B-24/24/24	5	6600.00
F15/10	5000	B-34	B-34/24/24	5	6600.00
F15/11	10000	B-34	B-24/24/24	5	12500.00
F15/12	10000	B-55	B-34/24/24	5	12500.00
F15/13	20000	B-55	B-34/24/24	5	19900.00

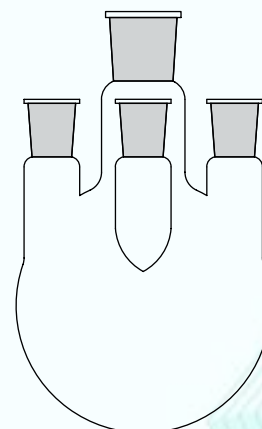

F16- FLASKS

Distilling, With Side arm

Product Code	Capacity (ml)	Approximate O.D. x Height	Quantity Per Case	Price/ Piece ₹
F16/01	100	64 x 210	5	200.00
F16/02	125	68 x 214	5	300.00
F16/03	250	88 x 226	5	350.00
F16/04	500	110 x 250	5	400.00
F16/05	1000	130 x 310	5	600.00
F16/06	2000	170 x 320	5	850.00

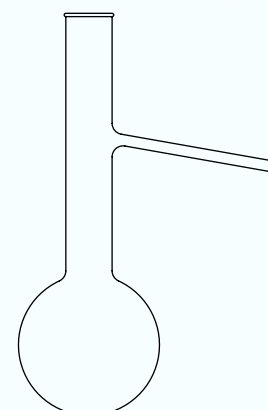

FLASKS

F17- CONICAL FLASKS

Erlenmeyer, Conical, Narrow Mouth

Product Code	Capacity (ml)	Quantity Per Case	Price/ Piece ₹
F17/01	10	5	55.00
F17/02	25	5	65.00
F17/03	50	5	75.00
F17/04	100	5	95.00
F17/05	150	5	110.00
F17/06	250	5	130.00
F17/07	500	5	200.00
F17/08	1000	5	390.00
F17/09	2000	5	1000.00
F17/10	3000	5	1700.00
F17/11	5000	5	3000.00



F18- CONICAL FLASKS

Erlenmeyer, Conical, Long Neck, Without Rim

Product Code	Capacity (ml)	Quantity Per Case	Price/ Piece ₹
F18/01	25	5	80.00
F18/02	50	5	80.00
F18/03	100	5	130.00
F18/04	150	5	160.00
F18/05	250	5	190.00
F18/06	500	5	260.00
F18/07	1000	5	490.00
F18/08	2000	5	1200.00

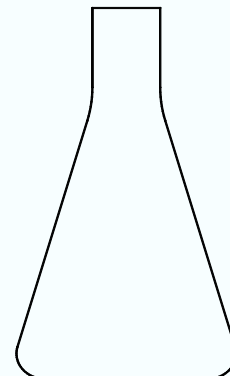

F19- CONICAL FLASKS

Erlenmeyer, Graduated, Conical, Amber with Narrow Mouth

Product Code	Capacity (ml)	Quantity Per Case	Price/ Piece ₹
F19/01	10	5	150.00
F19/02	25	5	170.00
F19/03	50	5	180.00
F19/04	100	5	200.00
F19/05	150	5	260.00
F19/06	250	5	280.00
F19/07	500	5	500.00
F19/08	1000	5	800.00
F19/09	2000	5	1800.00

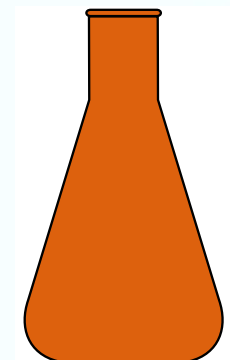

FLASKS

F20- CONICAL FLASKS

Erlenmeyer, Conical, Narrow Mouth With Interchangeable Joints

Product Code	Capacity (ml)	Quantity Per Case	Price/ Piece ₹
F20/01	10	5	120.00
F20/02	25	5	130.00
F20/03	50	5	140.00
F20/04	100	5	180.00
F20/05	150	5	200.00
F20/06	250	5	220.00
F20/07	500	5	350.00
F20/08	1000	5	700.00

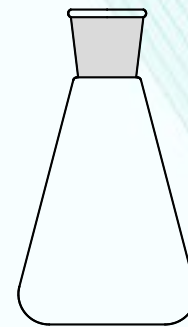

F21- TILT MEASURE FLASKS

Automatic (Sampler) with I/C Reservoir

Product Code	Measure Cap.	Flask Capacity (ml)	Quantity Per Case	Price/ Piece ₹
F21/01	5	250	5	500.00
F21/02	10	250	5	500.00
F21/03	15	250	5	300.00
F21/04	20	500	5	640.00
F21/05	25	500	5	720.00

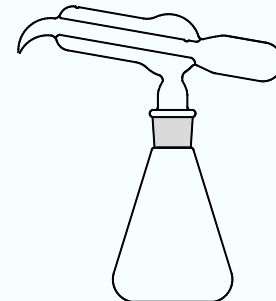

F22- CONICAL FLASKS

Erlenmeyer, Conical, Narrow Mouth With Interchangeable Stopper, Amber

Product Code	Capacity (ml)	Interchange - able Joint	Quantity Per Case	Price/ Piece ₹
F22/01	25	B-14	5	340.00
F22/02	50	B-19	5	360.00
F22/03	100	B-24	5	450.00
F22/04	150	B-24	5	500.00
F22/05	250	B-24	5	590.00
F22/06	500	B-24	5	800.00
F22/07	1000	B-24	5	1500.00

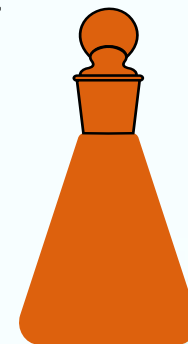

F23- CONICAL FLASKS

Erlenmeyer, Conical, Narrow Mouth With Interchangeable Stopper

Product Code	Capacity (ml)	Interchange - able Joint	Quantity Per Case	Price/ Piece ₹
F23/01	10	B-14	5	165.00
F23/02	25	B-14	5	175.00
F23/03	50	B-19	5	200.00
F23/04	100	B-24	5	255.00
F23/05	150	B-24	5	275.00
F23/06	250	B-24	5	315.00
F23/07	500	B-24	5	450.00
F23/08	1000	B-24	5	775.00
F23/09	2000	B-34	5	1500.00
F23/10	3000	B-34	5	2100.00
F23/11	5000	B-34	5	5500.00

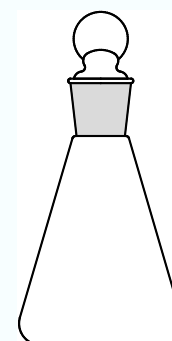

FLASKS

F24- CONICAL FLASKS

Conical, With Screw Cap

Product Code	Capacity (ml)	Quantity Per Case	Price/ Piece ₹
F24/01	25	5	160.00
F24/02	50	5	200.00
F24/03	100	5	270.00
F24/04	150	5	300.00
F24/05	250	5	360.00
F24/06	500	5	460.00
F24/07	1000	5	800.00
F24/08	2000	5	1400.00
F24/09	5000	5	6000.00

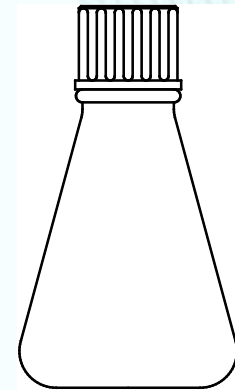

F25- CONICAL FLASKS

Erlenmeyer, Conical, Baffled, With Screw Cap

Product Code	Capacity (ml)	Quantity Per Case	Price/ Piece ₹
F25/01	100	5	290.00
F25/02	150	5	325.00
F25/03	250	5	395.00
F25/04	500	5	490.00
F25/05	1000	5	850.00
F25/06	2000	5	1450.00
F25/07	3000	5	2000.00
F25/08	5000	5	5600.00

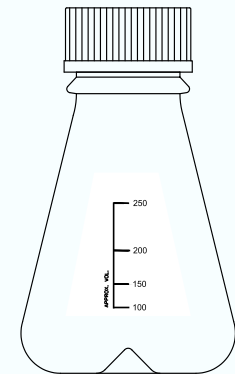

F26- CONICAL FLASKS

Erlenmeyer, Conical, Wide Mouth

Product Code	Capacity (ml)	Quantity Per Case	Price/ Piece ₹
F26/01	25	5	80.00
F26/02	50	5	80.00
F26/03	100	5	130.00
F26/04	150	5	160.00
F26/05	250	5	190.00
F26/06	500	5	260.00
F26/07	1000	5	490.00
F26/08	2000	5	1200.00

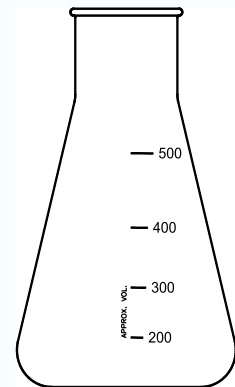

F27- FILTER FLASKS

Filtering, Bolt Neck, With Tubulation

Product Code	Capacity (ml)	Quantity Per Case	Price/ Piece ₹
F27/01	50	5	160.00
F27/02	100	5	250.00
F27/03	250	5	425.00
F27/04	500	5	590.00
F27/05	1000	5	1100.00
F27/06	2000	5	2000.00
F27/07	5000	5	6400.00
F27/08	10000	5	13440.00
F27/09	20000	5	26000.00

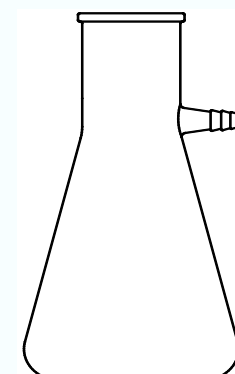

FLASKS

F28- IODINE FLASKS

Iodine Determination, With Interchangeable Stopper

Product Code	Capacity (ml)	Interchange - - able Joint	Quantity Per Case	Price/ Piece ₹
F28/01	100	B-24	5	250.00
F28/02	250	B-24	5	330.00
F28/03	500	B-24	5	460.00
F28/04	1000	B-24	5	1000.00
F28/05	Spare Stopper B24			85.00

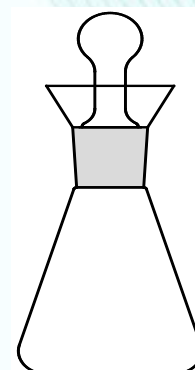

F29- KJELDAHL FLASKS

Kjeldahl, Round Bottom, Tooled Neck

Product Code	Capacity (ml)	Interchange - - able Joint	Quantity Per Case	Price/ Piece ₹
F29/01	10	B-14	5	130.00
F29/02	30	B-14	5	135.00
F29/03	100	B-19	5	230.00
F29/04	300	B-24	5	360.00
F29/05	500	B-24	5	630.00
F29/06	800	B-24	5	900.00

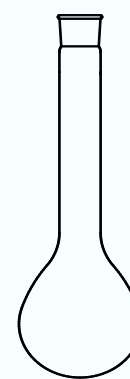

F30- KJELDAHL FLASKS

Kjeldahl, Round Bottom, Interchangeable Joint

Product Code	Capacity (ml)	Interchange - - able Joint	Quantity Per Case	Price/ Piece ₹
F30/01	10	B-14	5	130.00
F30/02	30	B-14	5	170.00
F30/03	100	B-19	5	320.00
F30/04	300	B-24	5	425.00
F30/05	500	B-24	5	820.00
F30/06	800	B-24	5	960.00

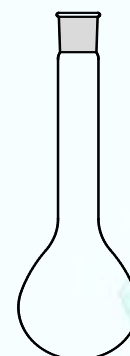

FLASKS

F31- VOLUMETRIC FLASKS

Volumetric With Interchangeable Solid Glass Stopper, Accuracy as per Class A, With Certificate

Product Code	Capacity (ml)	Tolerance (\pm ml)	Stopper Size	Price/ Piece ₹
F31/01	1	0.02	B-10	230.00
F31/02	2	0.03	B-10	230.00
F31/03	5	0.02	B-10	340.00
F31/04	10	0.02	B-10	400.00
F31/05	20	0.04	B-10	425.00
F31/06	25	0.04	B-10	430.00
F31/07	50	0.06	B-10	450.00
F31/08	100	0.10	B-14	470.00
F31/09	200	0.15	B-14	690.00
F31/10	250	0.20	B-14	700.00
F31/11	500	0.25	B-19	1000.00
F31/12	1000	0.50	B-19	1400.00
F31/13	2000	0.80	B-24	2400.00

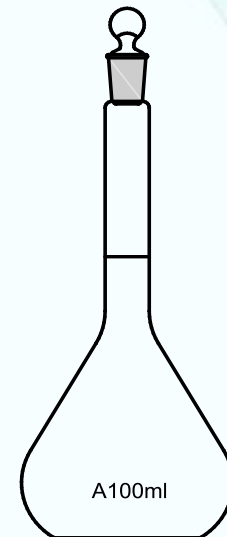

F32- VOLUMETRIC FLASKS

Volumetric With Interchangeable Solid Glass Stopper, Accuracy as per NABL Class A, With Certificate

Product Code	Capacity (ml)	Tolerance (\pm ml)	Stopper Size	Price/ Piece ₹
F32/01	5	0.02	B-10	800.00
F32/02	10	0.02	B-10	800.00
F32/03	20	0.04	B-10	850.00
F32/04	25	0.04	B-10	750.00
F32/05	50	0.06	B-10	750.00
F32/06	100	0.10	B-14	850.00
F32/07	200	0.15	B-14	1100.00
F32/08	250	0.20	B-14	1200.00
F32/09	500	0.25	B-19	1300.00
F32/10	1000	0.50	B-19	1000.00
F32/11	2000	0.80	B-24	3000.00

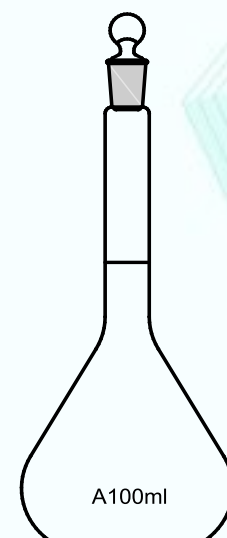

FLASKS

F33- VOLUMETRIC FLASKS

Volumetric With Interchangeable Solid Glass Stopper, Accuracy as per Class B

Product Code	Capacity (ml)	Tolerance (\pm ml)	Stopper Size	Price/ Piece ₹
F33/01	1	0.05	B-10	90.00
F33/02	2	0.05	B-10	90.00
F33/03	5	0.05	B-10	110.00
F33/04	10	0.05	B-10	120.00
F33/05	20	0.08	B-10	160.00
F33/06	25	0.08	B-10	180.00
F33/07	50	0.12	B-10	190.00
F33/08	100	0.20	B-14	210.00
F33/09	200	0.30	B-14	300.00
F33/10	250	0.30	B-14	330.00
F33/11	500	0.50	B-19	500.00
F33/12	1000	0.80	B-19	800.00
F33/13	2000	1.20	B-24	1600.00
F33/14	3000	1.80	B-29	4000.00
F33/15	5000	2.40	B-34	7500.00

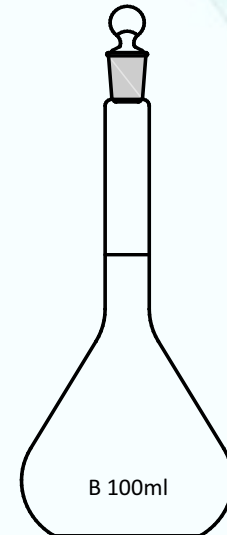

F34- VOLUMETRIC FLASKS

Volumetric With Interchangeable Solid Glass Stopper, Accuracy as per Class A, Amber, With Certificate

Product Code	Capacity (ml)	Tolerance (\pm ml)	Stopper Size	Price/ Piece ₹
F34/01	5	0.02	B-10	560.00
F34/02	10	0.02	B-10	625.00
F34/03	25	0.04	B-10	650.00
F34/04	50	0.06	B-10	660.00
F34/05	100	0.10	B-14	700.00
F34/06	200	0.15	B-14	890.00
F34/07	250	0.20	B-14	900.00
F34/08	500	0.25	B-19	1500.00
F34/09	1000	0.50	B-19	2300.00
F34/10	2000	0.80	B-24	3600.00

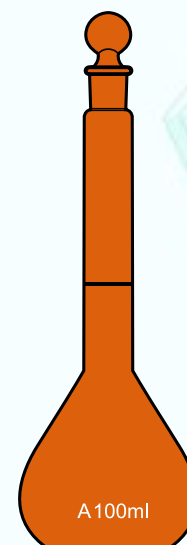

FLASKS

F35- VOLUMETRIC FLASKS

Volumetric With Interchangeable Solid Glass Stopper, Accuracy as per NABL Class A, Amber, With Certificate

Product Code	Capacity (ml)	Tolerance (±ml)	Stopper Size	Price/ Piece ₹
F35/01	5	0.02	B-10	800.00
F35/02	10	0.02	B-10	850.00
F35/03	25	0.04	B-10	900.00
F35/04	50	0.06	B-10	1000.00
F35/05	100	0.10	B-14	1100.00
F35/06	200	0.15	B-14	1200.00
F35/07	250	0.20	B-14	1250.00
F35/08	500	0.25	B-19	1800.00
F35/09	1000	0.50	B-19	2500.00
F35/10	2000	0.80	B-24	4500.00

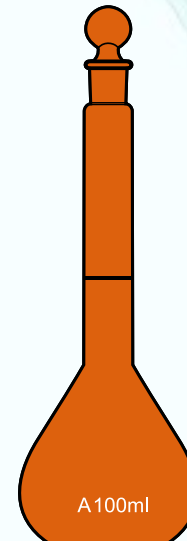

F36- VOLUMETRIC FLASKS

Volumetric With Interchangeable Solid Glass Stopper, Accuracy as per Class B, Amber, With Certificate

Product Code	Capacity (ml)	Tolerance (±ml)	Stopper Size	Price/ Piece ₹
F36/01	1	0.05	B-10	200.00
F36/02	2	0.05	B-10	200.00
F36/03	5	0.05	B-10	230.00
F36/04	10	0.05	B-10	300.00
F36/05	25	0.08	B-10	360.00
F36/06	50	0.12	B-10	450.00
F36/07	100	0.20	B-14	480.00
F36/08	200	0.30	B-14	660.00
F36/09	250	0.30	B-14	675.00
F36/10	500	0.50	B-19	1170.00
F36/11	1000	0.80	B-19	1500.00
F36/12	2000	1.20	B-24	3200.00

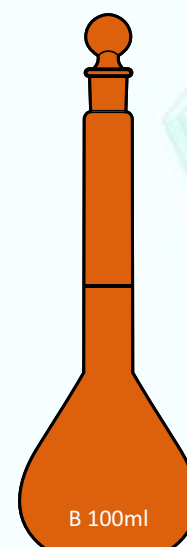

FUNNELS

F37- FUNNELS

PLAIN 60° Angle, Long Stem

Product Code	Diameter mm	Quantity Per Case	Price/ Piece ₹
F37/01	15	5	50.00
F37/02	25	5	55.00
F37/03	35	5	65.00
F37/04	50	5	70.00
F37/05	65	5	80.00
F37/06	75	5	100.00
F37/07	100	5	150.00
F37/08	125	5	350.00
F37/09	150	5	500.00
F37/10	200	5	1375.00
F37/11	250	5	1800.00
F37/12	300	5	3300.00
F37/13	400	5	5300.00

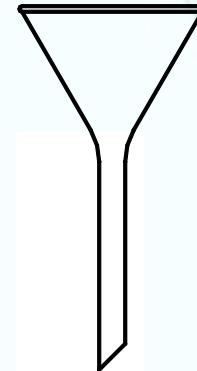

F38- FUNNELS

Amber, Long Stem

Product Code	Diameter mm	Quantity Per Case	Price/ Piece ₹
F38/01	35	5	110.00
F38/02	50	5	110.00
F38/03	65	5	115.00
F38/04	75	5	135.00
F38/05	100	5	148.00
F38/06	125	5	395.00
F38/07	150	5	490.00
F38/08	200	5	950.00

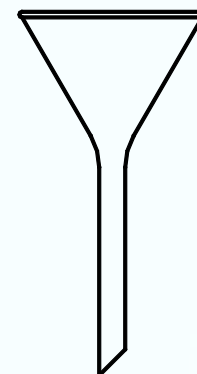

F39- FUNNELS

Powder Funnel, Solid Addition, Plain, Without Cone

Product Code	Diameter mm	Quantity Per Case	Price/ Piece ₹
F39/01	55	5	125.00
F39/02	65	5	130.00
F39/03	75	5	150.00
F39/04	100	5	230.00
F39/05	125	5	450.00
F39/06	150	5	900.00
F39/07	200	5	1000.00
F39/08	250	5	2100.00

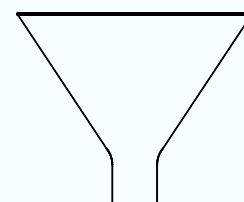

FUNNELS

F40- FUNNELS

Powder Funnel, Solid Addition, Amber, Without Cone

Product Code	Diameter mm	Quantity Per Case	Price/ Piece ₹
F40/01	50	5	190.00
F40/02	65	5	200.00
F40/03	75	5	240.00
F40/04	100	5	320.00
F40/05	125	5	690.00
F40/06	150	5	930.00
F40/07	200	5	2100.00

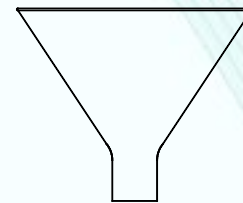

F41- FUNNELS

Powder Funnel, Solid Addition, With Cone

Product Code	Capacity (ml)	Interchange - able Joint	Quantity Per Case	Price/ Piece ₹
F41/01	50	B-14	5	150.00
F41/02	50	B-19	5	130.00
F41/03	50	B-24	5	180.00
F41/04	65	B-14	5	180.00
F41/05	65	B-19	5	180.00
F41/06	65	B-24	5	180.00
F41/07	75	B-14	5	180.00
F41/08	75	B-19	5	220.00
F41/09	75	B-24	5	220.00
F41/10	100	B-24	5	320.00
F41/11	100	B-34	5	320.00
F41/12	125	B-24	5	500.00
F41/13	125	B-34	5	525.00
F41/14	125	B-24	5	900.00

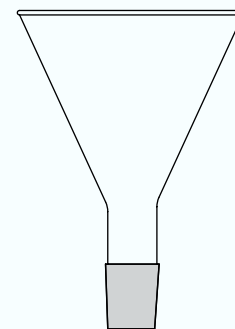

F42- FUNNELS

Funnel Test Tubes

Product Code	Capacity mm	Quantity Per Case	Price/ Piece ₹
F42/01	15	5	140.00
F42/02	30	5	200.00

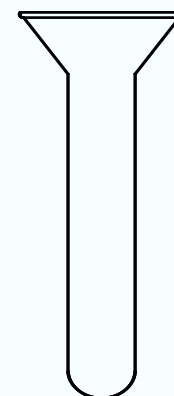

FUNNELS

F43- ADDITION FUNNELS

Dropping Funnel With Glass Stopcock / PTFE Rotaflow

Product Code	Capacity (ml)	Interchange - - able Joint	Quantity Per Case	Price/ Piece ₹
F43/01	50	B-19	5	360.00
F43/02	50	B-24	5	390.00
F43/03	100	B-19	5	480.00
F43/04	100	B-24	5	480.00
F43/05	250	B-19	5	600.00
F43/06	250	B-24	5	600.00
F43/07	500	B-24	5	750.00

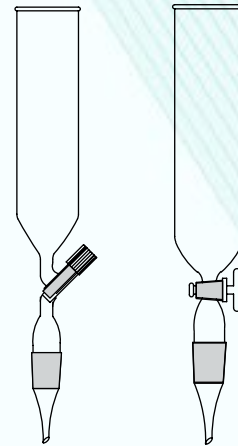

F44- ADDITION FUNNELS

Dropping Funnel With Solid PTFE Stopcock

Product Code	Capacity (ml)	Socket	Cone	Quantity Per Case	Price/ Piece ₹
F44/01	25	B-14	B-14	5	675.00
F44/02	50	B-14	B-14	5	675.00
F44/03	50	B-19	B-19	5	675.00
F44/04	100	B-14	B-14	5	800.00
F44/05	100	B-19	B-19	5	800.00
F44/06	100	B-24	B-24	5	800.00
F44/07	250	B-14	B-14	5	1000.00
F44/08	250	B-19	B-19	5	1000.00
F44/09	500	B-19	B-19	5	1200.00
F44/10	500	B-24	B-24	5	1200.00
F44/11	1000	B-24	B-24	5	2200.00
F44/12	1000	B-29	B-29	5	2200.00
F44/13	1000	B-34	B-34	5	2300.00



F45- ADDITION FUNNELS

Dropping Funnel With Glass Stopcock / PTFE Rotaflow

Product Code	Capacity (ml)	Socket	Cone	Quantity Per Case	Price/ Piece ₹
F45/01	25	B-14	B-14	5	430.00
F45/02	50	B-14	B-14	5	430.00
F45/03	50	B-19	B-19	5	430.00
F45/04	100	B-14	B-14	5	600.00
F45/05	100	B-19	B-19	5	600.00
F45/06	100	B-24	B-24	5	600.00
F45/07	250	B-14	B-14	5	790.00
F45/08	250	B-19	B-19	5	790.00
F45/09	500	B-19	B-19	5	1000.00
F45/10	500	B-24	B-24	5	1000.00
F45/11	1000	B-24	B-24	5	1800.00
F45/12	1000	B-29	B-29	5	1800.00
F45/13	1000	B-34	B-34	5	1900.00

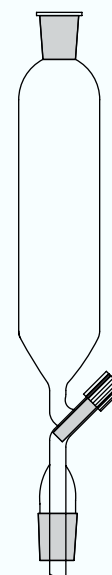

FUNNELS

F46- ADDITION FUNNELS

Dropping Funnels, Graduated With Solid PTFE Stopcock

Product Code	Capacity (ml)	Socket	Cone	Quantity Per Case	Price/ Piece ₹
F46/01	25	B-14	B-14	5	800.00
F46/02	50	B-14	B-14	5	800.00
F46/03	50	B-19	B-19	5	800.00
F46/04	100	B-14	B-14	5	950.00
F46/05	100	B-19	B-19	5	950.00
F46/06	100	B-24	B-24	5	950.00
F46/07	250	B-14	B-14	5	1300.00
F46/08	250	B-19	B-19	5	1300.00
F46/09	250	B-24	B-24	5	1300.00
F46/10	500	B-19	B-19	5	1700.00
F46/11	500	B-24	B-24	5	1700.00
F46/12	1000	B-29	B-29	5	2400.00
F46/13	1000	B-34	B-34	5	2400.00



F47- ADDITION FUNNELS

Dropping Funnels, Graduated With Glass Stopcock / PTFE Rotaflow

Product Code	Capacity (ml)	Socket	Cone	Quantity Per Case	Price/ Piece ₹
F47/01	25	B-14	B-14	5	430.00
F47/02	50	B-14	B-14	5	500.00
F47/03	50	B-19	B-19	5	500.00
F47/04	100	B-14	B-14	5	630.00
F47/05	100	B-19	B-19	5	630.00
F47/06	100	B-24	B-24	5	630.00
F47/07	250	B-14	B-14	5	1100.00
F47/08	250	B-19	B-19	5	1100.00
F47/09	250	B-24	B-24	5	1100.00
F47/10	500	B-19	B-19	5	1400.00
F47/11	500	B-24	B-24	5	1400.00
F47/12	1000	B-29	B-29	5	2300.00
F47/13	1000	B-34	B-34	5	2300.00

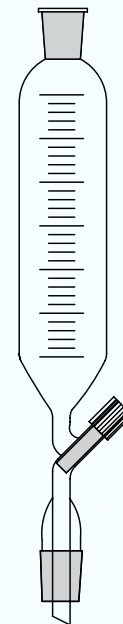

F48- ADDITION FUNNELS

Pressure Equilising Cylindrical, With Solid PTFE Stopcock

Product Code	Capacity (ml)	Socket	Cone	Quantity Per Case	Price/ Piece ₹
F48/01	50	B-19	B-19	5	1000.00
F48/02	100	B-19	B-19	5	1200.00
F48/03	100	B-24	B-24	5	1200.00
F48/04	250	B-19	B-19	5	1600.00
F48/05	250	B-24	B-24	5	1600.00
F48/06	500	B-19	B-19	5	2000.00
F48/07	500	B-24	B-24	5	2000.00
F48/08	1000	B-24	B-24	5	3680.00

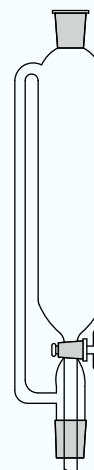

FUNNELS

F49- ADDITION FUNNELS

Pressure Equilising Cylindrical, With Glass Stopcock / PTFE Rotaflow

Product Code	Capacity (ml)	Socket	Cone	Quantity Per Case	Price/ Piece ₹
F49/01	50	B-19	B-19	5	700.00
F49/02	100	B-19	B-19	5	1000.00
F49/03	100	B-24	B-24	5	1000.00
F49/04	250	B-19	B-19	5	1480.00
F49/05	250	B-24	B-24	5	1480.00
F49/06	500	B-19	B-19	5	1900.00
F49/07	500	B-24	B-24	5	1900.00
F49/08	1000	B-24	B-24	5	2800.00

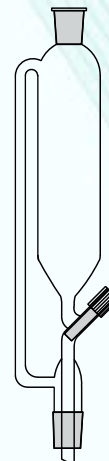

F50- ADDITION FUNNELS

Pressure Equilising Cylindrical, Graduated, With PTFE Stopcock

Product Code	Capacity (ml)	Socket	Cone	Quantity Per Case	Price/ Piece ₹
F50/01	100	B-19	B-19	5	1500.00
F50/02	100	B-24	B-24	5	1500.00
F50/03	100	B-29	B-29	5	1500.00
F50/04	250	B-19	B-19	5	1800.00
F50/05	250	B-24	B-24	5	1800.00
F50/06	250	B-29	B-29	5	1800.00
F50/07	500	B-19	B-19	5	2200.00
F50/08	500	B-24	B-24	5	2200.00
F50/09	500	B-29	B-29	5	2200.00
F50/10	1000	B-34	B-24	5	3200.00

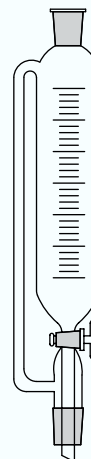

F51- ADDITION FUNNELS

Pressure Equilising Cylindrical, Graduated, With Glass Stopcock / PTFE Rotaflow

Product Code	Capacity (ml)	Socket	Cone	Quantity Per Case	Price/ Piece ₹
F51/01	25	B-19	B-19	5	800.00
F51/02	50	B-24	B-24	5	850.00
F51/03	100	B-19	B-19	5	1300.00
F51/04	100	B-24	B-24	5	1300.00
F51/05	100	B-29	B-29	5	1300.00
F51/06	250	B-19	B-19	5	1600.00
F51/07	250	B-24	B-24	5	1600.00
F51/08	250	B-29	B-29	5	1600.00
F51/09	500	B-19	B-19	5	2100.00
F51/10	500	B-24	B-24	5	2100.00
F51/11	500	B-29	B-29	5	3000.00
F51/12	1000	B-34	B-24	5	4500.00

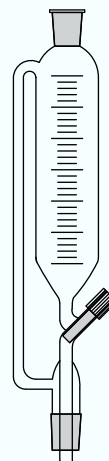

FUNNELS

F52- SEPARATING FUNNELS

Globe Shape, With Glass Stopcock / PTFE Rotaflow

Product Code	Capacity (ml)	Interchange - able Joint	Quantity Per Case	Price/ Piece ₹
F52/01	125	B-19	5	500.00
F52/02	250	B-19	5	600.00
F52/03	500	B-24	5	700.00
F52/04	1000	B-29	5	1250.00
F52/05	2000	B-34	5	2250.00
F52/06	3000	B-34	5	4550.00
F52/07	5000	B-34	5	8500.00
F52/08	10000	B-34	5	14400.00
F52/09	20000	B-55	5	15200.00

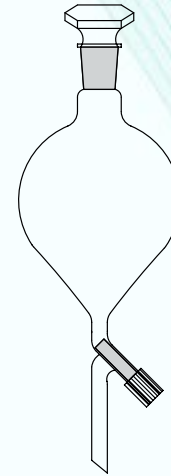

F53- SEPARATING FUNNELS

Globe Shape, Glass Stopcock / PTFE Stopcock

Product Code	Capacity (ml)	Interchange - able Joint	Quantity Per Case	Price/ Piece ₹
F53/01	125	B-19	5	640.00
F53/02	250	B-19	5	700.00
F53/03	500	B-24	5	890.00
F53/04	1000	B-29	5	1300.00
F53/05	2000	B-34	5	2300.00
F53/06	3000	B-34	5	5000.00
F53/07	5000	B-34	5	7000.00
F53/08	10000	B-34	5	14500.00
F53/09	20000	B-55	5	20000.00

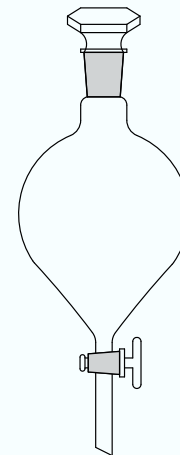

F54- SEPARATING FUNNELS

Pear Shape, With Inter- Changeable Stopper & PTFE Stopcock

Product Code	Capacity (ml)	Interchange - able Joint	Quantity Per Case	Price/ Piece ₹
F54/01	25	B-14	5	600.00
F54/02	60	B-14	5	680.00
F54/03	125	B-19	5	900.00
F54/04	250	B-19	5	1200.00
F54/05	500	B-24	5	1600.00
F54/06	1000	B-29	5	2000.00
F54/07	2000	B-34	5	4000.00
F54/08	3000	B-34	5	9000.00
F54/09	5000	B-34	5	9900.00
F54/10	10000	B-34	5	17400.00
F54/11	20000	B-34	5	24000.00

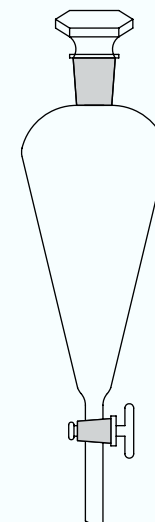

FUNNELS

F55- SEPARATING FUNNELS

Pear Shape, With Inter- Changeable Stopper & PTFE Stopcock

Product Code	Capacity (ml)	Interchange - able Joint	Quantity Per Case	Price/ Piece ₹
F55/01	25	B-14	5	380.00
F55/02	60	B-14	5	400.00
F55/03	125	B-19	5	690.00
F55/04	250	B-19	5	720.00
F55/05	500	B-24	5	900.00
F55/06	1000	B-29	5	1600.00
F55/07	2000	B-34	5	2600.00
F55/08	3000	B-34	5	5640.00
F55/09	5000	B-34	5	8500.00
F55/10	10000	B-34	5	14400.00
F55/11	20000	B-34	5	15200.00

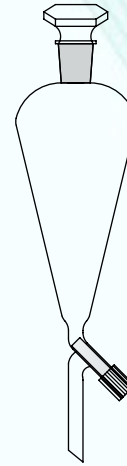

F56- GAS GENERATOR

Product Code	Capacity (ml)	Quantity Per Case	Price/ Piece ₹
F56/01	250	5	3000.00
F56/02	500	5	5000.00
F56/03	1000	5	6500.00

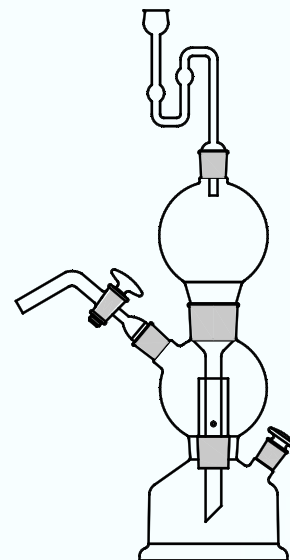

KETTLES

K01- KETTLES

Resin Reaction

Product Code	Capacity (ml)	Inner Dia. (mm)	Height (mm)	Quantity Per Case	Price/ Piece ₹
K01/01	500	77	140	5	1800.00
K01/02	1000	105	150	5	2250.00
K01/03	2000	105	300	5	2970.00
K01/04	3000	155	210	5	3480.00
K01/05	4000	155	280	5	3890.00
K01/06	5000	155	350	5	4320.00

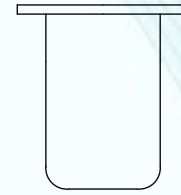

K02- KETTLES

Jacketed Kettle (Reactor), Flat Bottom, Flat Flange, Open Top

Product Code	Capacity (ml)	Inner Dia. (mm)	Height (mm)	Quantity Per Case	Price/ Piece ₹
K02/01	500	77	140	5	2800.00
K02/02	1000	105	150	5	3570.00
K02/03	2000	105	300	5	4760.00
K02/04	3000	155	210	5	5770.00
K02/05	4000	155	280	5	6510.00
K02/06	5000	155	350	5	6810.00

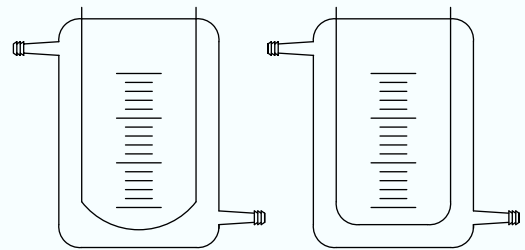

K03- KETTLES

Jacketed Kettle (Reactor), Flat Bottom, Flat Flange

Product Code	Capacity (ml)	Inner Dia. (mm)	Height (mm)	Quantity Per Case	Price/ Piece ₹
K03/01	500	77	140	5	4000.00
K03/02	1000	105	150	5	5100.00
K03/03	2000	105	300	5	6800.00
K03/04	3000	155	210	5	8250.00
K03/05	4000	155	280	5	9300.00
K03/06	5000	155	350	5	9800.00

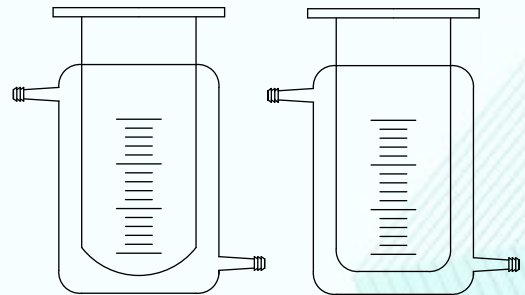

K04- KETTLES

Jacketed Kettle (Reactor), Flat Bottom, Flat Flange, With Bottom Drain Nozzle

Product Code	Capacity (ml)	Inner Dia. (mm)	Height (mm)	Quantity Per Case	Price/ Piece ₹
K04/01	500	77	140	5	4300.00
K04/02	1000	105	150	5	5500.00
K04/03	2000	105	300	5	7200.00
K04/04	3000	155	210	5	8600.00
K04/05	4000	155	280	5	9700.00
K04/06	5000	155	350	5	10500.00

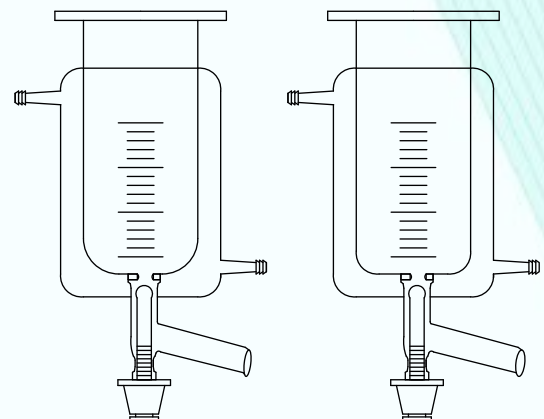

KETTLES

K05- KETTLE LID

For Jacketed & Non Jacketed Kettles (Reactors), Flat Flange, Customization Possible as per Requirement

Product Code	Capacity (ml)	Centre Socket	Side Socket	Quantity Per Case	Price/ Piece ₹
K05/01	500	B-24	B-19/19/19	5	700.00
K05/02	1000	B-34	B24/24/24	5	780.00
K05/03	2000	B-34	B24/24/24	5	1050.00
K05/04	3000	B-34	B24/24/24	5	1050.00
K05/05	4000	B-34	B24/24/24	5	1050.00
K05/06	5000	B-34	B24/24/24	5	1350.00

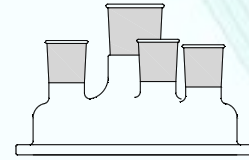

K06- KETTLES

Cylindrical, With Round/Flat Bottom, With Baffles

Product Code	Capacity (ml)	Inner Dia. (mm)	Height (mm)	Quantity Per Case	Price/ Piece ₹
K06/01	500	77	140	5	700.00
K06/02	1000	105	150	5	780.00
K06/03	2000	105	300	5	1050.00
K06/04	3000	155	210	5	1050.00
K06/05	4000	155	280	5	1050.00
K06/06	5000	155	350	5	1350.00

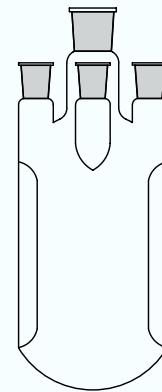

K07- KETTLE QRC

Quick Release Coupling for Reactor

Product Code	Size	Quantity Per Case	Price/ Piece ₹
K07/01	3"	5	4000.00
K07/02	4"	5	5500.00
K07/03	6"	5	7500.00
K07/04	8"	5	9000.00

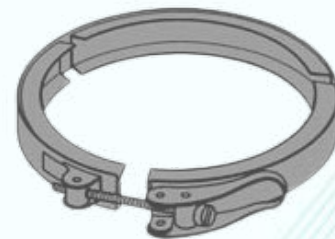

K08- KETTLE GASKET

PTFE Expanded Gasket

Product Code	Size	Quantity Per Case	Price/ Piece ₹
K08/01	3"	5	135.00
K08/02	4"	5	170.00
K08/03	6"	5	240.00



Various Options Available

- Jacketed Kettle (Reactor), Flat Bottom, Flat Flange, With Baffles
- Jacketed Kettle (Reactor), Flat Bottom, Flat Flange, With Overflow Nozzle
- Jacketed Kettle (Reactor), Flat Bottom, Flat Flange, With Baffles, With Overflow Nozzle, With Bottom Drain Valve
- Kettle Without Jacket, Flat Bottom, Flat Flange, With Baffles
- Kettle Without Jacket, Flat Bottom, Flat Flange, With Overflow Nozzle
- Kettle Without Jacket, Flat Bottom, Flat Flange, With Bottom Drain Valve
- Kettle Without Jacket, Flat Bottom, Flat Flange, With Baffles, With Overflow Nozzle, With Bottom Drain Valve

PIPETTES

P01- PIPETTES

Serological Pipette, Class A, With Certificate

Product Code	Capacity (ml)	Graduation (ml)	Tolerance (\pm ml)	Price/ Piece ₹
P01/01	0.1	0.01	0.006	300.00
P01/02	0.2	0.01	0.006	300.00
P01/03	1	0.01	0.006	300.00
P01/04	2	0.02	0.01	300.00
P01/05	5	0.05	0.05	300.00
P01/06	10	0.1	0.05	350.00
P01/07	25	0.2	0.1	400.00



P02- PIPETTES

Serological Pipette, Class B

Product Code	Capacity (ml)	Graduation (ml)	Tolerance (\pm ml)	Price/ Piece ₹
P02/01	0.1	0.01	0.01	110.00
P02/02	0.2	0.01	0.01	110.00
P02/03	1	0.01	0.01	100.00
P02/04	2	0.02	0.1	100.00
P02/05	5	0.05	0.1	100.00
P02/06	10	0.1	0.1	110.00
P02/07	25	0.2	0.2	160.00



P03- PIPETTES

Serological Pipette, NABL Certified

Product Code	Capacity (ml)	Graduation (ml)	Tolerance (\pm ml)	Price/ Piece ₹
P03/01	0.1	0.01	0.006	700.00
P03/02	0.2	0.01	0.006	700.00
P03/03	1	0.01	0.006	700.00
P03/04	2	0.02	0.01	700.00
P03/05	5	0.05	0.03	700.00
P03/06	10	0.1	0.05	700.00
P03/07	25	0.2	0.1	750.00



P04- PIPETTES

Measuring (Mohr Type), Class A, With Certificate

Product Code	Capacity (ml)	Graduation (ml)	Tolerance (\pm ml)	Price/ Piece ₹
P04/01	0.1	0.01	0.006	300.00
P04/02	0.2	0.01	0.006	300.00
P04/03	0.5	0.02	0.006	300.00
P04/04	1	0.01	0.01	300.00
P04/05	2	0.02	0.03	300.00
P04/06	5	0.05	0.05	300.00
P04/07	10	0.1	0.1	350.00
P04/08	25	0.2	0.2	400.00



PIPETTES

P05- PIPETTES

Measuring (Mohr Type), Class B

Product Code	Capacity (ml)	Graduation (ml)	Tolerance (\pm ml)	Price/ Piece ₹
P05/01	0.1	0.01	0.01	110.00
P05/02	0.2	0.01	0.01	110.00
P05/03	0.5	0.02	0.01	110.00
P05/04	1	0.01	0.01	110.00
P05/05	2	0.02	0.02	110.00
P05/06	5	0.05	0.05	110.00
P05/07	10	0.1	0.1	110.00
P05/08	25	0.2	0.2	160.00



P06- PIPETTES

Measuring (Mohr Type), NABL Certified

Product Code	Capacity (ml)	Graduation (ml)	Tolerance (\pm ml)	Price/ Piece ₹
P06/01	0.1	0.01	0.006	700.00
P06/02	0.2	0.01	0.006	700.00
P06/03	0.5	0.02	0.006	700.00
P06/04	1	0.01	0.01	700.00
P06/05	2	0.02	0.03	700.00
P06/06	5	0.05	0.05	700.00
P06/07	10	0.1	0.1	700.00
P06/08	25	0.2	0.2	750.00



P07- PIPETTES

Volumetric, Class A, With Certificate

Product Code	Capacity (ml)	Tolerance (\pm ml)	Quantity Per Case	Price/ Piece ₹
P07/01	1	0.007	5	263.00
P07/02	2	0.01	5	263.00
P07/03	3	0.01	5	263.00
P07/04	4	0.015	5	263.00
P07/05	5	0.015	5	269.00
P07/06	10	0.02	5	269.00
P07/07	15	0.02	5	323.00
P07/08	20	0.03	5	323.00
P07/09	25	0.03	5	329.00
P07/10	50	0.05	5	427.00
P07/11	100	0.08	5	531.00
P07/12	6	0.015	5	269.00
P07/13	7	0.015	5	269.00
P07/14	8	0.020	5	269.00
P07/15	9	0.020	5	269.00



PIPETTES

P08- PIPETTES

Volumetric, Class B

Product Code	Capacity (ml)	Tolerance (\pm ml)	Quantity Per Case	Price/ Piece ₹
P08/01	1	0.02	5	90.00
P08/02	2	0.02	5	90.00
P08/03	3	0.03	5	95.00
P08/04	4	0.03	5	95.00
P08/05	5	0.03	5	100.00
P08/06	10	0.04	5	100.00
P08/07	15	0.05	5	120.00
P08/08	20	0.06	5	120.00
P08/09	25	0.06	5	150.00
P08/10	50	0.10	5	210.00
P08/11	100	0.16	5	300.00
P08/12	6	0.04	5	100.00
P08/13	7	0.04	5	100.00
P08/14	8	0.04	5	100.00
P08/15	9	0.04	5	100.00



P09- PIPETTES

Volumetric, NABL Certified

Product Code	Capacity (ml)	Tolerance (\pm ml)	Quantity Per Case	Price/ Piece ₹
P09/01	1	0.006	5	600.00
P09/02	2	0.006	5	600.00
P09/03	5	0.010	5	600.00
P09/04	10	0.020	5	650.00
P09/05	20	0.030	5	650.00
P09/06	25	0.030	5	650.00
P09/07	50	0.050	5	700.00
P09/08	100	0.080	5	800.00



P10- PIPETTES

Milk Testing, Gerber, One Mark

Product Code	Capacity (ml)	Tolerance (\pm ml)	Price/ Piece ₹
P10/01	10.75	5	140.00

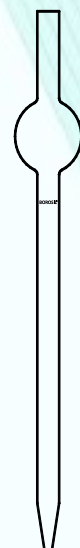

P11- PIPETTES

Pasture Pipette (Dropper), With Rubber Teat

Product Code	Length (mm)	Quantity Per Case	Price/ Piece ₹
P11/01	150	5	30.00
P11/02	200	5	40.00

P12- PIPETTES

Drum Pipette, For Sampling, Tube 19mm O.D. & 13mm I.D.

Product Code	Length (mm)	Quantity Per Case	Price/ Piece ₹
P12/01	500	5	550.00

STIRRERS

S01- STIRRERS

Button Type Glass Rod With Teflon Blade

Product Code	To Pass Through	Rod Diameter (mm)	Rod Length mm	Price/ Piece ₹
S01/01	B-19	6	450	330.00
S01/02	B-24	6	450	330.00
S01/03	B-29	6	450	330.00
S01/04	B-19	6	600	350.00
S01/05	B-24	6	600	350.00
S01/06	B-29	6	600	350.00
S01/07	B-19	8	450	330.00
S01/08	B-24	8	450	380.00
S01/09	B-29	8	450	440.00
S01/10	B-34	8	450	450.00
S01/11	B-55	8	450	920.00
S01/12	B-19	8	600	380.00
S01/13	B-24	8	600	390.00
S01/14	B-29	8	600	470.00
S01/15	B-34	8	600	395.00
S01/16	B-55	8	600	960.00
S01/17	B-24	8	750	550.00
S01/18	B-29	8	750	610.00
S01/19	B-34	8	750	630.00
S01/20	B-55	8	750	1100.00
S01/21	B-24	10	450	415.00
S01/22	B-29	10	450	480.00
S01/23	B-34	10	450	500.00
S01/24	B-55	10	450	960.00
S01/25	B-24	10	600	470.00
S01/26	B-29	10	600	500.00
S01/27	B-34	10	600	625.00
S01/28	B-55	10	600	990.00
S01/29	B-24	10	750	540.00
S01/30	B-29	10	750	620.00
S01/31	B-34	10	750	650.00
S01/32	B-55	10	750	1100.00

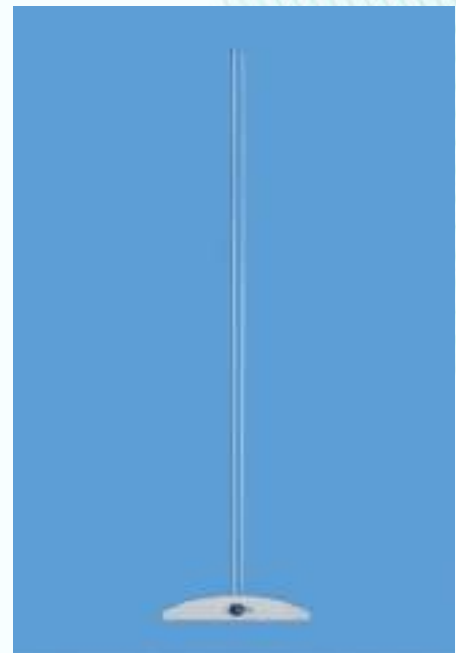

S02- STIRRING BLADE

PTFE Half Moon Blade For Glass Rod

Product Code	Capacity (ml)	Quantity Per Case	Price/ Piece ₹
S02/01	B-19	5	190.00
S02/02	B-24	5	220.00
S02/03	B-29	5	265.00
S02/04	B-34	5	425.00
S02/05	B-45	5	640.00
S02/06	B-55	5	960.00



STIRRERS

S03- STIRRERS

Button Type Glass Stirring Rod

Product Code	Rod Diameter (mm)	Rod Length mm	Quantity Per Case	Price/ Piece ₹
S03/01	6	450	5	130.00
S03/02	7	450	5	150.00
S03/03	8	450	5	170.00
S03/04	8	450	5	170.00
S03/05	10	450	5	200.00
S03/06	10	500	5	200.00
S03/07	10	600	5	220.00
S03/08	10	750	5	330.00
S03/09	12	450	5	290.00
S03/10	12	600	5	290.00
S03/11	12	750	5	380.00



S04- STIRRERS

Double Button Type Glass Stirring Rod

Product Code	Rod Diameter (mm)	Rod Length mm	Quantity Per Case	Price/ Piece ₹
S04/01	8	450	5	270.00
S04/02	8	600	5	300.00
S04/03	10	450	5	340.00
S04/04	10	500	5	360.00
S04/05	10	600	5	410.00
S04/06	10	750	5	470.00
S04/07	12	600	5	550.00
S04/08	12	750	5	640.00



S05- STIRRERS

Anchor Type Glass Stirring Rod

Product Code	Rod Diameter (mm)	Rod Length mm	Quantity Per Case	Price/ Piece ₹
S05/01	8	450	5	740.00
S05/02	8	600	5	770.00
S05/03	10	450	5	830.00
S05/04	10	500	5	860.00
S05/05	10	600	5	950.00
S05/06	10	750	5	1010.00
S05/07	12	600	5	1160.00
S05/08	12	750	5	1280.00

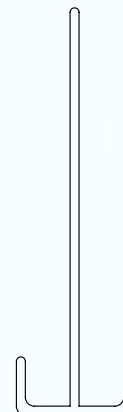

S06- STIRRERS

Propeller Type Glass Stirring Rod

Product Code	Rod Diameter (mm)	Rod Length mm	Quantity Per Case	Price/ Piece ₹
S06/01	8	450	5	900.00
S06/02	8	600	5	930.00
S06/03	10	450	5	1020.00
S06/04	10	500	5	1050.00
S06/05	10	600	5	1140.00
S06/06	10	750	5	1260.00

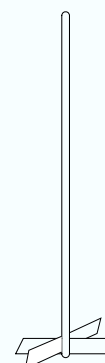

STIRRERS

S07- STIRRERS (PTFE SLEEVED)

Impeller Blade, SS Rod With PTFE Sleaving

Product Code	Rod Diameter (mm)	Rod Length mm	Quantity Per Case	Price/ Piece ₹
S07/01	8	450	5	3400.00
S07/02	8	600	5	3900.00
S07/03	10	450	5	3800.00
S07/04	10	500	5	4400.00
S07/05	10	600	5	4900.00
S07/06	10	750	5	5500.00
S07/07	12	600	5	6100.00
S07/08	12	750	5	6500.00



S08- STIRRERS (PTFE SLEEVED)

Anchor Blade, SS Rod With PTFE Sleaving

Product Code	Rod Diameter (mm)	Rod Length mm	Quantity Per Case	Price/ Piece ₹
S08/01	8	450	5	3400.00
S08/02	8	600	5	3900.00
S08/03	10	450	5	3800.00
S08/04	10	500	5	4400.00
S08/05	10	600	5	4900.00
S08/06	10	750	5	5500.00
S08/07	12	600	5	6100.00
S08/08	12	750	5	6500.00



S09- STIRRERS (PTFE SLEEVED)

Pitch Blade, SS Rod With PTFE Sleaving

Product Code	Rod Diameter (mm)	Rod Length mm	Quantity Per Case	Price/ Piece ₹
S09/01	8	450	5	3600.00
S09/02	8	600	5	4100.00
S09/03	10	450	5	4000.00
S09/04	10	500	5	4600.00
S09/05	10	600	5	5100.00
S09/06	10	750	5	5700.00
S09/07	12	600	5	6300.00
S09/08	12	750	5	6700.00



S10- STIRRING BARS

PTFE Coated Magnetic Stirring Rod

Product Code	Length (mm)	Quantity Per Case	Price/ Piece ₹
S10/01	10 x 240	5	900.00
S10/02	10 x 300	5	1000.00



STIRRERS

S11- STIRRING BARS

Cylindrical Shape, PTFE Coated, Magnetic Stirring Bar

Product Code	Size (D x L) (mm)	Quantity Per Case	Price/ Piece ₹
S11/01	5 x 8	5	250.00
S11/02	5 x 10	5	230.00
S11/03	6 x 12	5	220.00
S11/04	6 x 19	5	230.00
S11/05	6 x 25	5	270.00
S11/06	6 x 30	5	330.00
S11/07	8 x 12	5	225.00
S11/08	8 x 20	5	260.00
S11/09	8 x 25	5	280.00
S11/10	8 x 30	5	310.00
S11/11	8 x 40	5	350.00
S11/12	10 x 40	5	480.00
S11/13	10 x 45	5	500.00
S11/14	10 x 50	5	550.00
S11/15	10 x 65	5	550.00
S11/16	13 x 35	5	600.00
S11/17	13 x 38	5	640.00
S11/18	13 x 50	5	750.00
S11/19	13 x 75	5	800.00



S12- STIRRING BARS

Oval Shape, PTFE Coated, Magnetic Stirring Bar

Product Code	Size (D x L) (mm)	Quantity Per Case	Price/ Piece ₹
S12/01	4 x 8	5	420.00
S12/02	5 x 10	5	450.00
S12/03	6 x 15	5	480.00
S12/04	10 x 20	5	725.00
S12/05	12 x 25	5	850.00
S12/06	16 x 30	5	950.00
S12/07	16 x 35	5	980.00
S12/08	20 x 40	5	1180.00
S12/09	20 x 50	5	1250.00
S12/10	20 x 64	5	1400.00
S12/11	20 x 70	5	1600.00



STIRRERS

S13- STIRRING BARS

Cross Shaped Shape, PTFE Coated, Magnetic Stirring Bar

Product Code	Size (D x L) (mm)	Quantity Per Case	Price/ Piece ₹
S13/01	10 x 10	5	650.00
S13/02	20 x 20	5	775.00
S13/03	25 x 25	5	925.00
S13/04	30 x 30	5	975.00
S13/05	38 x 38	5	1200.00



S14- STIRRING BARS

Dumbbell Shape, PTFE Coated, Magnetic Stirring Bar

Product Code	Size (D x L) (mm)	Quantity Per Case	Price/ Piece ₹
S14/01	9 x 32 x 35	5	750.00
S14/02	9 x 52 x 45	5	820.00



S15- STIRRING BARS

Gear Shape, PTFE Coated, Magnetic Stirring Bar

Product Code	Size (D x L) (mm)	Quantity Per Case	Price/ Piece ₹
S15/01	5 x 13	5	1200.00
S15/02	6 x 15	5	1210.00
S15/03	7 x 20	5	1220.00
S15/04	8 x 25	5	1220.00
S15/05	8 x 30	5	1250.00
S15/06	9 x 28	5	1290.00
S15/07	9 x 35	5	1320.00
S15/08	9 x 50	5	1390.00
S15/09	10 x 40	5	1550.00
S15/10	10 x 80	5	1920.00



S16- STUFFING BOX

PTFE Stuffing Box for Stirrers

Product Code	Joint Size	Quantity Per Case	Price/ Piece ₹
S16/01	B-14	5	585.00
S16/02	B-19	5	635.00
S16/03	B-24	5	745.00
S16/04	B-29	5	1055.00
S16/05	B-34	5	1190.00
S16/06	B-45	5	2200.00
S16/07	B-55	5	3360.00



S17- STUFFING BOX

Mercury Seal Gland With Sleeve - PTFE

Product Code	Joint Size	Quantity Per Case	Price/ Piece ₹
S17/01	B-19	5	2160.00
S17/02	B-24	5	2360.00
S17/03	B-29	5	2700.00
S17/04	B-34	5	3060.00
S17/05	B-55	5	4500.00



STIRRERS & STOPPERS

S18- STUFFING BOX

Mercury Seal Gland With Sleeve - Glass

Product Code	Joint Size	Quantity Per Case	Price/ Piece ₹
S18/01	B-14	5	400.00
S18/02	B-19	5	400.00
S18/03	B-24	5	450.00
S18/04	B-29	5	470.00
S18/05	B-34	5	490.00
S18/06	B-45	5	570.00
S18/07	B-55	5	780.00

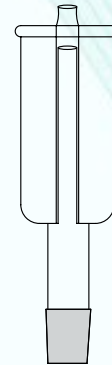

S19- STUFFING BOX

High Vacuum Seal Gland - PTFE

Product Code	Joint Size	Quantity Per Case	Price/ Piece ₹
S19/01	B-19	2	29200.00
S19/02	B-24	2	30400.00
S19/03	B-29	2	32900.00
S19/04	B-34	2	38400.00
S19/05	B-45	2	43800.00



S20- STOPPERS

Glass Stoppers, Hollow, Hexagonal Head

Product Code	Joint Size	Quantity Per Case	Price/ Piece ₹
S20/01	B-10	5	40.00
S20/02	B-14	5	45.00
S20/03	B-19	5	60.00
S20/04	B-24	5	75.00
S20/05	B-29	5	125.00
S20/06	B-34	5	160.00

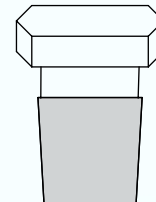

S21- STOPPERS

Glass Stoppers, Hollow, Penny Head

Product Code	Joint Size	Quantity Per Case	Price/ Piece ₹
S21/01	B-10	5	50.00
S21/02	B-14	5	60.00
S21/03	B-19	5	75.00
S21/04	B-24	5	110.00
S21/05	B-29	5	150.00
S21/06	B-34	5	250.00
S21/07	B-45	5	300.00
S21/08	B-55	5	400.00

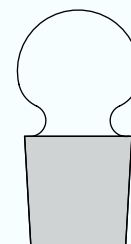

STOPPERS & SINTERED GLASSWARE

S22- STOPPERS

Glass Stoppers, Solid, Penny Head

Product Code	Joint Size	Quantity Per Case	Price/ Piece ₹
S22/01	B-10	5	50.00
S22/02	B-14	5	60.00
S22/03	B-19	5	80.00
S22/04	B-24	5	180.00
AMBER GLASS			
S22/05	B-10	5	80.00
S22/06	B-14	5	90.00
S22/07	B-19	5	140.00
S22/08	B-24	5	230.00

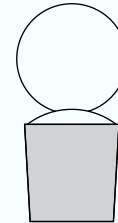

S23- STOPPERS

Glass Stoppers, Solid, For Reagent Bottles

Product Code	Joint Size	Quantity Per Case	Price/ Piece ₹
S23/01	B-14	5	70.00
S23/02	B-19	5	90.00
S23/03	B-24	5	110.00
S23/04	B-29	5	170.00
S23/05	B-34	5	250.00
S23/06	B-45	5	500.00



S24- SINTERED FUNNELS

Buchner Funnel, With Sintered Disc

Product Code	Capacity (ml)	Porosity Grade	Quantity Per Case	Price/ Piece ₹
S24/01	35	G1/G2/G3/G4	5	425.00
S24/02	80	G1/G2/G3/G4	5	720.00
S24/03	125	G1/G2/G3/G4	5	960.00
S24/04	200	G1/G2/G3/G4	5	1440.00
S24/05	500	G1/G2/G3/G4	5	3600.00
S24/06	1000	G1/G2/G3/G4	5	6600.00
S24/07	1500	G1/G2/G3/G4	5	23000.00
S24/08	2000	G1/G2/G3/G4	5	25000.00

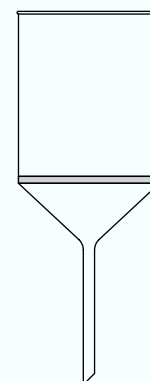

S25- SINTERED CRUCIBLE

Gooch Type, Low Form, With Sintered Disc

Product Code	Capacity (ml)	Porosity Grade	Quantity Per Case	Price/ Piece ₹
S25/01	15	G1/G2/G3/G4	5	230.00
S25/02	30	G1/G2/G3/G4	5	300.00
S25/03	50	G1/G2/G3/G4	5	540.00

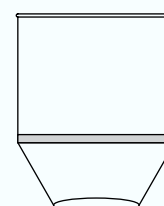

SINTERED GLASSWARE

S26- SINTERED TUBES

Sealed, With Reduced Ends, With Sintered Disc (Pipeline Filters)

Product Code	Capacity (ml)	Porosity Grade	Quantity Per Case	Price/ Piece ₹
S26/01	30	G1/G2/G3/G4	5	470.00
S26/02	65	G1/G2/G3/G4	5	1500.00
S26/03	90	G1/G2/G3/G4	5	3200.00
S26/04	125	G1/G2/G3/G4	5	8500.00
S26/05	50	G1/G2/G3/G4	5	1200.00

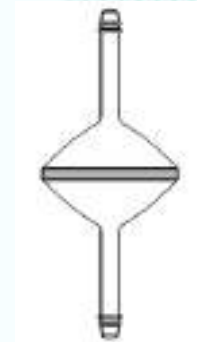

S27- SINTERED GLASSWARE

Micro Filtration Assembly (Millipore Type), With Rubber Cork

Product Code	Holder Capacity (ml)	Flask Capacity (ml)	Quantity Per Case	Price/ Piece ₹
S27/01	35	50	5	4400.00
S27/02	35	100	5	4500.00
S27/03	35	250	5	4600.00
S27/04	35	500	5	4700.00
S27/05	100	250	5	4800.00
S27/06	100	500	5	4900.00
S27/07	100	1000	5	5100.00
S27/08	300	500	5	7400.00
S27/09	300	1000	5	7600.00
S27/10	300	2000	5	8280.00

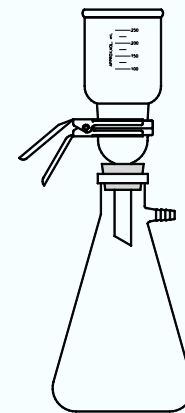

S28- SINTERED GLASSWARE

Micro Filtration Assembly (Millipore Type), With Glass I/C. Joints

Product Code	Holder Capacity (ml)	Flask Capacity (ml)	Quantity Per Case	Price/ Piece ₹
S28/01	35	50	5	4600.00
S28/02	35	100	5	4700.00
S28/03	35	250	5	4800.00
S28/04	35	500	5	4900.00
S28/05	100	250	5	5000.00
S28/06	100	500	5	5100.00
S28/07	100	1000	5	5400.00
S28/08	300	500	5	7700.00
S28/09	300	1000	5	7900.00
S28/10	300	2000	5	8500.00

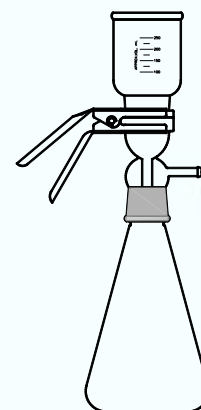

TUBES

T01- TUBES

Test Tubes, With Rim

Product Code	Capacity (ml)	Approx. O.D. x Length (mm)	Quantity Per Case	Price/ Piece ₹
T01/01	3	10 x 75	5	7.00
T01/02	5	12 x 75	5	8.00
T01/03	8	12 x 100	5	10.00
T01/04	10	15 x 125	5	14.00
T01/05	15	15 x 150	5	17.00
T01/06	25	18 x 150	5	19.00
T01/07	50	25 x 150	5	30.00
T01/08	75	25 x 200	5	40.00
T01/09	100	32 x 200	5	60.00
T01/10	175	38 x 200	5	70.00



T02- TUBES

Test Tubes, Without Rim

Product Code	Capacity (ml)	Approx. O.D. x Length (mm)	Quantity Per Case	Price/ Piece ₹
T02/01	3	10 x 75	5	7.00
T02/02	5	12 x 75	5	8.00
T02/03	8	12 x 100	5	9.00
T02/04	10	15 x 125	5	13.00
T02/05	15	15 x 150	5	16.00
T02/06	25	18 x 150	5	30.00
T02/07	50	25 x 150	5	40.00
T02/08	75	25 x 200	5	60.00
T02/09	100	32 x 200	5	70.00
T02/10	175	38 x 200	5	80.00



T03- TUBES

Test Tubes, Graduated, Without Stopper

Product Code	Capacity (ml)	Approx. O.D. x Length (mm)	Quantity Per Case	Price/ Piece ₹
T03/01	10	15 x 125	5	70.00
T03/02	15	15 x 150	5	75.00
T03/03	25	18 x 150	5	90.00
T03/04	50	25 x 150	5	120.00
T03/05	75	25 x 200	5	130.00
T03/06	100	32 x 200	5	180.00

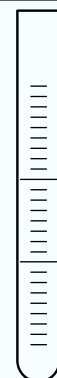

T04- TUBES

Test Tubes, Plain, With Interchangeable Stopper

Product Code	Capacity (ml)	O.D. x Lgth. (mm)	Joint Size	Quantity Per Case	Price/ Piece ₹
T04/01	10	15 x 125	B-14	5	100.00
T04/02	15	15 x 150	B-14	5	115.00
T04/03	20	18 x 150	B-14	5	125.00
T04/04	25	25 x 150	B-19	5	150.00
T04/05	50	25 x 200	B-19	5	175.00
T04/06	75	32 x 200	B-24	5	300.00
T04/07	100	38 x 200	B-24	5	375.00



TUBES

T05- TUBES

Test Tubes, Amber, With Interchangeable Stopper

Product Code	Capacity (ml)	O.D. x Lgth. (mm)	Joint Size	Quantity Per Case	Price/ Piece ₹
T05/01	10	15 x 125	B-14	5	160.00
T05/02	15	15 x 150	B-14	5	175.00
T05/03	20	18 x 150	B-14	5	190.00
T05/04	25	25 x 150	B-19	5	220.00
T05/05	50	25 x 200	B-19	5	250.00
T05/06	75	32 x 200	B-24	5	390.00
T05/07	100	38 x 200	B-24	5	450.00



T06- TUBES

Test Tubes, Plain, Graduated, With Interchangeable Stopper

Product Code	Capacity (ml)	O.D. x Lgth. (mm)	Joint Size	Quantity Per Case	Price/ Piece ₹
T06/01	10	15 x 125	B-14	5	200.00
T06/02	15	15 x 150	B-14	5	230.00
T06/03	25	25 x 150	B-19	5	275.00
T06/04	50	25 x 200	B-19	5	300.00
T06/05	100	38 x 200	B-24	5	375.00



T07- TUBES

Test Tubes, Amber, Graduated, With Interchangeable Stopper

Product Code	Capacity (ml)	O.D. x Lgth. (mm)	Joint Size	Quantity Per Case	Price/ Piece ₹
T07/01	10	15 x 125	B-14	5	250.00
T07/02	15	15 x 150	B-14	5	280.00
T07/03	25	25 x 150	B-19	5	350.00
T07/04	50	25 x 200	B-19	5	415.00
T07/05	100	38 x 200	B-24	5	500.00



T08- TUBES

Centrifuge Tube, Conical Bottom, Plain

Product Code	Capacity (ml)	Approx. O.D. x Length (mm)	Quantity Per Case	Price/ Piece ₹
T08/01	15	17 x 120	5	82.00



T09- TUBES

Centrifuge Tube, Conical Bottom, Graduated

Product Code	Capacity (ml)	Approx. O.D. x Length (mm)	Quantity Per Case	Price/ Piece ₹
T09/01	15	17 x 120	5	80.00
T09/02	50	29 x 135	5	180.00

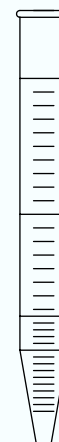

T10- TUBES

Centrifuge Tube, Conical Bottom, Graduated, With Stopper

Product Code	Capacity (ml)	Approx. O.D. x Length (mm)	Quantity Per Case	Price/ Piece ₹
T10/01	15	17 x 139	5	200.00
T10/02	50	29 x 151	5	350.00

TUBES

T11- TUBES

Centrifuge Tube, Graduated, With Screw Cap

Product Code	Capacity (ml)	Approx. O.D. x Length (mm)	Quantity Per Case	Price/ Piece ₹
PLAIN				
T11/01	10	16 x 125	5	100.00
T11/02	15	17 x 139	5	110.00
GRADUATED				
T11/03	10	16 x 125	5	125.00
T11/04	15	17 x 139	5	195.00
GRADUATED AMBER				
T11/05	10	16 x 125	5	300.00
T11/06	15	17 x 139	5	350.00



T12- TUBES

Culture, Media, Round Bottom, Plain, With Screw Cap

Product Code	Capacity (ml)	Approx. O.D. x Length (mm)	Quantity Per Case	Price/ Piece ₹
T12/01	5	15 x 75	5	40.00
T12/02	10	15 x 125	5	45.00
T12/03	30	25 x 100	5	65.00
T12/04	50	25 x 150	5	70.00
T12/05	60	25 x 200	5	80.00



T13- TUBES

Culture, Media, Flat Bottom, Plain, With Screw Cap

Product Code	Capacity (ml)	Approx. O.D. x Length (mm)	Quantity Per Case	Price/ Piece ₹
T13/01	5	16 x 50	5	40.00
T13/02	15	25 x 57	5	50.00
T13/03	30	25 x 95	5	60.00
T13/04	50	25 x 145	5	80.00



T14- TUBES

Culture, Media, Flat Bottom, Amber, With Screw Cap

Product Code	Capacity (ml)	Approx. O.D. x Length (mm)	Quantity Per Case	Price/ Piece ₹
T14/01	5	16 x 50	5	80.00
T14/02	15	25 x 57	5	110.00
T14/03	30	25 x 95	5	120.00
T14/04	50	25 x 145	5	170.00



T15- TUBES

Thile's Melting Point Tube

Product Code	Approx. O.D. x Height	Quantity Per Case	Price/ Piece ₹
T15/01	18 x 125	5	90.00
T15/02	25 x 150	5	120.00

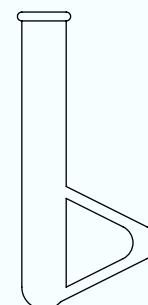

TUBES

T16- TUBES

Capillary Tubes, Both Ends Open, 100mm Long

Product Code	Make	Quantity Per Case	Price/ Case ₹
T16/01	Hand Made	100	150.00
T16/02	Machine Made	100	200.00



Capillary Tubes, One End Open, 100mm Long

Product Code	Make	Quantity Per Case	Price/ Case ₹
T16/03	Hand Made	100	170.00
T16/04	Machine Made	100	230.00

T17- TUBES

Capillary Tubes, Both Ends Open, 100mm Long

Product Code	Make	Quantity Per Case	Price/ Case ₹
T17/01	T	5	600.00
T17/02	U	5	450.00
T17/03	Y	5	650.00

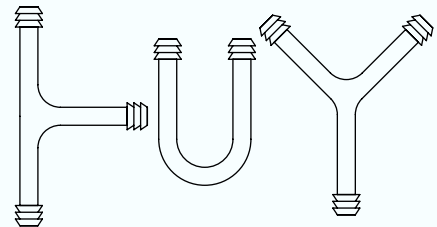

T18- TUBES

Calcium Chloride Tubes

Product Code	Joint Size	Approx. O.D. x Length (mm)	Quantity Per Case	Price/ Piece ₹
T18/01	B-10	15 x 75	5	900.00
T18/02	B-14	15 x 125	5	950.00

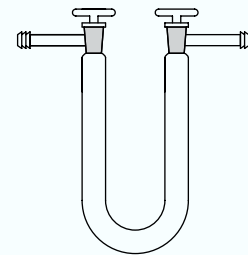

T19- U TUBE MANOMETER

Manometer - 'U' Tube With Scale, Fitted on Wooden Stand

Product Code	Range mm of Hg	Quantity Per Case	Price/ Case ₹
T19/01	250 - 0 - 250	1	2400.00
T19/02	500 - 0 - 500	1	2700.00

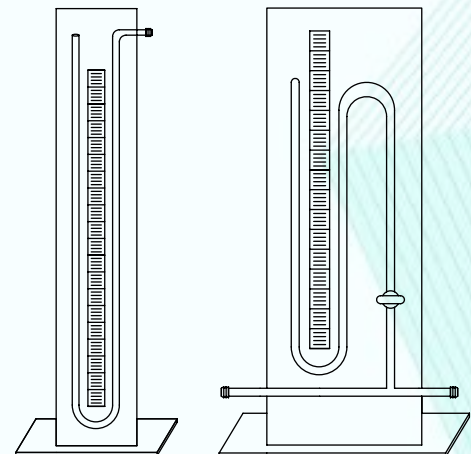

T20- U TUBE MANOMETER (ANSCHUTZ)

Anschutz Manometer, With Mercury & Wooden Stand

Product Code	Range mm of Hg	Quantity Per Case	Price/ Case ₹
T20/01	120 - 0 - 120	1	18300.00

T21- Mc-Leod Gauge

Mc-Leod Gauge, With Mercury & Stand

Product Code	Range mm of Hg	Quantity Per Case	Price/ Case ₹
C21/01	10 to 0.001	1	18500.00



T22- PLASTIC CLIP to hold standard joints

HSN Code : 7017

CAT No.	Joint Size	Quantity Per Pack	Price / Pack
T22/01	B 14	10	200.00
T22/02	B 19	10	250.00
T22/03	B 24	10	300.00
T22/04	B 29	10	400.00
T22/05	B 34	10	On request



G-285



METALWARE

Essential to Science

Explore, Experiment, Excel



**YOUR TRUSTED PARTNER FOR SCIENTIFIC LAB
GLASSWARE, EQUIPMENTS & CONSUMABLES**

M01- BURETTE CLAMP Sheet Metal Die Press Cork Lined Jaws.

HSN Code : 9027

CAT No.	Rod Size in Inch	Description	Price/Piece ₹
M01/01	9 Medium	M. S. Powder Coated	150.00
M01/02	10 Medium	Brass Chrome Plated	230.00



L-882

M02 BURETTE CLAMP HOLDER Fisher Type Single / Double

HSN Code : 9027

CAT No.	Description	Price/Piece ₹
M02/01	Single Burette M.S.	130.00
M02/02	Double Burette M.S.	220.00
M02/03	Double Burette Extra Strong M.S.	350.00
M02/04	Single Burette Plastic	75.00
M02/05	Double Burette Plastic	150.00



L-883

M03- BURETTE CLAMP Powder Coated Four Finger Clamp With Boss Head

HSN Code : 9027

CAT No.	Description	Price/Piece ₹
M03/01	Made of Aluminum die casting 9" Rod MS	200.00
M03/02	Brass chrome plated with chrome plated boss head	490.00



L-884

M04- CONDENSER CLAMP (RETORT) Made of Alu. Alloy Die Casting With 9" Rod

HSN Code : 9027

CAT No.	Description	Price/Piece ₹
M04/01	Cork lined finished	285.00
M04/02	Brass Casting Chrome Plated 10" Rod	392.00



L-885

M05- CONDENSER & FLASK CLAMP Industrial Heavy Type without Boss Head to Hold Articles from 40 mm to 125 mm Dia.

HSN Code : 9027

CAT No.	Rod Size in Inch	Price/Piece ₹	CAT No.	Rod Size in Inch	Price/Piece ₹
Al. Alloy Powder Coated or M.S.			Brass Casting Chrome Plated		
M05/01	10	350.00	L-886-11	10	495.00
M05/02	12	395.00	L-886-12	12	795.00



L-886

M06- CONDENSER CLAMP Coaxial three finger rubber covered spring controlled by adjustable coaxial brass nut to hold upto 75mm dia article MS rod without boss head

HSN Code : 9027

CAT No.	Rod Size in Inch	Price/Piece ₹	CAT No.	Rod Size in Inch	Price/Piece ₹
Al. Alloy Powder Coated or M.S.			Brass Casting Chrome Plated		
M06/01	10	280.00	L-887-11	10	420.00
M06/02	12	350.00	L-887-12	12	495.00



L-887

M07- THREE FINGER CLAMP DOUBLE KEY JAWS ADJUSTABLE BY TWO INDEPENDENT SCREW 10" CHROME PLATED WITHOUT BOSS HEAD

HSN Code : 9027

CAT No.	Description	Price/Piece ₹
M07/01	ALUMINIUM ALLOY POWDER COATED	500.00
M07/02	BRASS MOULDED M.S. ROD 10"	680.00



L-888

M08- THREE FINGER CLAMP ROUTINE QUALITY MADE OF AL. ALLOY DIE CASTING TO HOLD UP TO 90MM DIA PROVIDED WITH MS 9" ROD CHROME PLATED JAWS ARE RUBBER LINED

HSN Code : 9027

CAT No.	Description	Price/Piece ₹
M08/01	ALUMINIUM ALLOY POWDER COATED	390.00
M08/02	BRASS MOULDED M.S. ROD 10"	495.00



L-889

M09- FOUR FINGER JUMBO CLAMP 12" ROD M.S. CHROME PLATED WITHOUT BOSS HEAD

HSN Code : 9027

CAT No.	Description	Price/Piece ₹
M09/01	ALUMINIUM ALLOY POWDER COATED	525.00
M09/02	BRASS CHROME PLATED	850.00

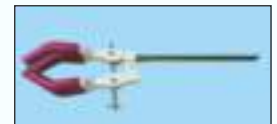

L-890

M10- BOSS HEAD MADE OF CAST IRON T TYPE SCREW POWDER COATED

HSN Code : 9027

CAT No.	Description	Price/Piece ₹
M10/01	TO HOLD 12 MM ROD	98.00
M10/02	TO HOLD 16 MM ROD	130.00
M10/03	TO HOLD 25 MM ROD	180.00
M10/04	TO HOLD 19 MM ROD	245.00
M10/05	TO HOLD 34 MM ROD	300.00



L-892

M11- BURETTES STAND WITH ROD, BURETTES CLAMP & BOSS HEAD COMPLETE SET POWDER COATED HEAVY.

HSN Code : 9027

CAT No.	Size in Inch	Price/Piece ₹
M11/01	8 x 5	850.00
M11/02	9 x 6	950.00

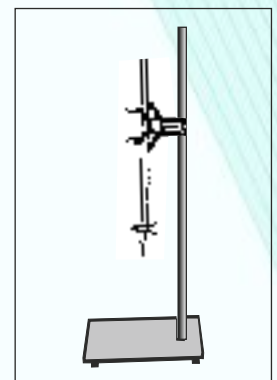

L-898

M12- BURETTES STAND WITH ROD, BURETTES CLAMP & BOSS HEAD COMPLETE SET BLACK PAINTED, COLLEGE GRADE SHEET MADE COLLEGE USE.

HSN Code : 9027

CAT No.	Size in Inch	Price/Piece ₹
M12/01	8 x 5	775.00
M12/02	9 x 6	880.00

M13- BURETTE STAND HEAVY INDUSTRIAL, Made of thick cast iron, Synthetic hammer finish powder coated. rod anodised with one end machine threaded with washer and nut. HSN Code : 9027

CAT No.	Plate Size Inch	Plate Size L x W (mm)	Rod Size Dia x Length (mm)	Price/Piece ₹
M13/01	8 x 5	200 x 125	12 x 600	510.00
M13/02	9 x 6	225 x 150	12 x 750	690.00
M13/03	12 x 7	300 x 175	12 x 750	1120.00

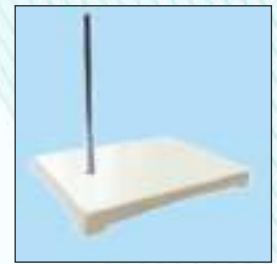

L-894

M14- BURETTE STAND EXPORT QUALITY, Superior Finish for Industrial use. HSN Code : 9027

CAT No.	Size	Rod Size	Price/Piece ₹
M14/01	8 x 5 (200 x 125mm)	12 x 650	750.00
M14/02	9 x 6 (225 x 150mm)	12 x 750	950.00



L-895

M15- Rectangular Retort Stand, Complete Stainless Steel with Rod NEW for Industrial use HSN Code : 9027

CAT No.	Plate Size L x W (mm)	Rod Size Doa. x Length (mm)	Price/Piece ₹
M15/01	200 x 125 (8" x 5")	12 x 600	1020.00
M15/02	225 x 150 (9" x 6")	12 x 750	1470.00



L-896

M16- Rectangular Retort Stand, Iron Sheet Made, Black painted with Rod, COLLAGE GRADE HSN Code : 9027

CAT No.	Plate Size L x W (mm)	Rod Size Doa. x Length (mm)	Price/Piece ₹
M16/01	200 x 125 (8" x 5")	12 x 600	380.00
M16/02	225 x 150 (9" x 6")	12 x 750	500.00



L-897

M17- TRIPOD STAND TRIANGULAR Cast iron top and mild steel legs, Zinc plated synthetic hammer finish. Legs are bent outwards for stability, Heavy. HSN Code : 9027

CAT No.	Size in Inch	Price/Piece ₹
M17/01	7 x 5	150.00
M17/02	8 x 5	160.00
M17/03	8 x 4	140.00
M17/04	7 x 5 All Stainless Steel	270.00
M17/05	8 x 5 All Stainless Steel	300.00



L-901

M18- TRIPOD STAND, Black Painted Triangular Leg, Round Top HSN Code : 9027

CAT No.	H x W Inch	Price/Piece ₹
M18/01	7 x 4	130.00
M18/02	8 x 4	150.00
M18/03	8 x 5	220.00



L-902

M19- BUNSEN BURNER L.P.G. Gas Brass Tube

HSN Code : 9027

CAT No.	Description	Price / Piece ₹
M19/01	Heavy Base W/O Stopcock	275.00
M19/02	Heavy Base with Stopcock	375.00



L-907

M20- MECKER TYPE BURNER L.P.G. Gas Large Flam Brass tube, wire mesh top for microbiology/laminar

HSN Code : 9027

CAT No.	Description	Price / Piece ₹
M20/01	Mecker 18mm tube W/o Stopcock	730.00
M20/02	Mecker 18mm tube with Stopcock	870.00
M20/03	Mecker 25mm tube W/o Stopcock	825.00
M20/04	Mecker 25mm tube With Stop Cock	925.00



L-908

M21- RING BURNER used on Bunsen Gas Cylinder for Cooking, ideal for autoclave heating, water heating & canteen use.

HSN Code : 9027

CAT No.	Size Dia	Price / Piece ₹
M21/01	6"	2200.00
M21/02	8"	2800.00
M21/03	12"	3600.00

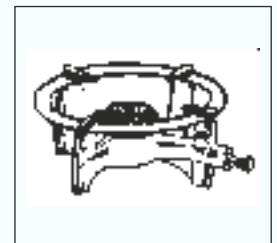

L-909

M22- CRUCIBLES TONGS, Stainless Steel (Pair of Tong)

HSN Code : 9027

CAT No.	Size mm	Size in inch	Price / Piece ₹
M22/01	150	6	90.00
M22/02	200	8	120.00
M22/03	250	10	250.00
M22/04	300	12	375.00
M22/05	450	18	990.00
Furnace Tong			
M22/06	600	24	1200.00
M22/07	375	15	700.00



L-910

M23- CRUCIBLES TONGS, Galvanised Iron for Schools & Collages

HSN Code : 9027

CAT No.	Size mm	Size in inch	Price / Piece ₹
M23/01	150	6	45.00
M23/02	200	8	55.00



L-911

M24- BEAKER TONGS, FISHER TYPE Stainless Steel handling firmly from 100 ml to 250 ml.

HSN Code : 9027

CAT No.	Description	Price / Piece ₹
M24/01		205.00



L-912

M25- FLASK TONGS, FISHER TYPE Stainless Steel. It can firmly grip flasks of any shape from 100 to 2000 ml. The long handles extend beyond the finger hold, thus the weight of the flask is supported by the palm of the hand, overall length 230mm.

HSN Code : 9027



L-913

CAT No.	Description	Price / Piece ₹
M25/01		285.00

M26- RETORT RINGS With fixed boss heads, copper oxidised suitable for fastening on rods up to 12 mm dia.

HSN Code : 9027



L-914

CAT No.	Dia mm	Price/Piece	CAT No.	Dia mm	Price/Piece ₹
Stainless Steel			Ms Powder Coated		
M26/01	50	170.00	L-914-11	50	100.00
M26/02	65	175.00	L-914-12	65	110.00
M26/03	75	180.00	L-914-13	75	120.00
M26/04	100	195.00	L-914-14	100	130.00
M26/05	125	225.00	L-914-15	125	175.00
M26/06	150	On Request	L-914-16	150	220.00

M27- PINCH CLIP, MOHR'S TYPE, For compressing flexible tubings, provides a flat clamping surface on the tubing.

HSN Code : 9027



L-924

CAT No.	Description	Price / Piece ₹
M27/01	Steel Wire	17.00

M28- HOFFMAN SCREW CLIP Brass Nickel plated extra strong 25mm, Suitable for Light Wall Tubings & 50mm, Suitable for Heavy Wall tubings, Industrial Type.

HSN Code : 9027



L-925

CAT No.	Description	Price / Piece ₹
M28/01	12.5 mm (1/2")	150.00
M28/02	25.0 mm (1")	200.00
M28/03	50.0 mm (2")	490.00

M29- TEST TUBE HOLDER Thick flat iron wire, bright nickel plated

HSN Code : 9027



L-926

CAT No.	Description	Price / Piece ₹
M29/01	Polished Wooden Handle	60.00
M29/02	Plastic Handle (Collage Grade)	50.00
M29/03	Plastic Handle Brass N.P.	80.00

M30- FORCEPS, STRAIGHT S. S. fine Serrated Points, guide pin, corrugated handles.

HSN Code : 9027

CAT No.	Size mm	Price / Piece ₹
M30/01	100 (4")	50.00
M30/02	125 (5")	65.00
M30/03	150 (6")	100.00
M30/04	200 (8")	180.00
M30/05	250 (10")	250.00
M30/06	300 (12")	300.00



L-942

M31- FORCEPS, STRAIGHT, BLUNT POINT S. S. Serrated with Corrugated Handles.

HSN Code : 9027

CAT No.	Size mm	Price / Piece ₹
M31/01	125	85.00
M31/02	150	110.00
M31/03	200	190.00
M31/04	250	250.00



L-943

M32- SCISSORS, STRAIGHT STAINLESS STEEL

HSN Code : 9027

CAT No.	Size mm	Price / Piece ₹
Fine Point		
M32/01	100	180.00
M32/02	125	200.00
M32/03	150	300.00
M32/04	Tailor Scissor 200	950.00
M32/05	Tailor Scissor 250	1500.00
M32/06	Plastic Handle 200	300.00
Blunt Rounded End.		
M32/11	100	190.00
M32/12	125	210.00
M32/13	150	300.00
M32/14	200	950.00



L-944

M33- SCOOPS, For Laboratory, with fine handle or Stainless Steel Mirror Finish or Plastic

HSN Code : 9027

CAT No.	Capacity gms.	Price / Piece ₹
Stainless Steel		
M33/11	250	1095.00
M33/12	500	1295.00
M33/13	1000	1595.00
M33/14	2000	1875.00



L-945

M34- TEST SIEVE Brass Frames With S. S. Wire
Mesh, DIA 200 mm (8") Made from Imported Wire Mesh. T. C.
indicates test certificate.

HSN Code : 9604

CAT No.	B.S.S. 410/1969	ASTM 11/70	I.S.S. 460/1972	Microns	Price/Piece ₹	CAT No.	Price/Piece ₹
Without test certificate					With test certificate		
M34/01	4	5	4.000mm	4000	3040.00	M34/41	6160.00
M34/02	5	6	3.350mm	3353	3040.00	M34/42	6160.00
M34/03	6	7	2.800mm	2812	3040.00	M34/43	6160.00
M34/04	7	8	2.360mm	2411	3040.00	M34/44	6160.00
M34/05	8	10	2.000mm	2057	3040.00	M34/45	6160.00
M34/06	10	12	1.700mm	1680	3040.00	M34/46	6160.00
M34/07	12	14	1.400mm	1405	3040.00	M34/47	6160.00
M34/08	14	16	1.180mm	1204	3040.00	M34/48	6160.00
M34/09	16	18	1.000mm	1003	3040.00	M34/49	6160.00
M34/10	18	20	0.850mm	850	3040.00	M34/50	6160.00
M34/11	22	25	0.710mm	710	3040.00	M34/51	6160.00
M34/12	25	30	0.600mm	600	3040.00	M34/52	6160.00
M34/13	30	35	0.500mm	500	3040.00	M34/53	6160.00
M34/14	36	40	0.425mm	420	3040.00	M34/54	6160.00
M34/15	44	45	0.355mm	355	3040.00	M34/55	6160.00
M34/16	52	50	0.300mm	300	3040.00	M34/56	6160.00
M34/17	60	60	0.250mm	250	3040.00	M34/57	6160.00
M34/18	72	70	0.212mm	210	3040.00	M34/58	6160.00
M34/19	85	80	0.180mm	180	3040.00	M34/59	6160.00
M34/20	100	100	0.150mm	150	3040.00	M34/60	6160.00
M34/21	120	120	0.125mm	120	3040.00	M34/61	6160.00
M34/22	150	140	0.106mm	105	3040.00	M34/62	6160.00
M34/23	170	170	0.090mm	90	3040.00	M34/63	6160.00
M34/24	200	200	0.075mm	75	3040.00	M34/64	6160.00
M34/25	240	230	0.063mm	63	3560.00	M34/65	6300.00
M34/26	300	270	0.053mm	53	3560.00	M34/66	6300.00
M34/27	350	325	0.045mm	45	3560.00	M34/67	6300.00
M34/28	400	400	0.037mm	37	3560.00	M34/68	6300.00
M34/29	500	-	0.025mm	25	6600.00	M34/69	P.O.R.



L-611

* Class "A" with certificate will be supplied after received from JAYANT, Order cannot be cancelled.

M35- LID AND RECEIVER for test sieves JAYANT BRAND

HSN Code : 9604

CAT No.	Description	Price / Piece ₹
M35/01	Brass	4280.00
M35/02	Stainless Steel	4280.00

Test Sieve Made of Stainless Steel Frame Fitted with Stainless Steel Wire Mesh. Dia 200 mm
 Price on request.



L-612

M36- SPATULA MICRO, Made of S. S. Rod with tapered flat blade at one side and rounded flat blade at other side

HSN Code : 9027

CAT No.	Size mm (Flat)	Price / Piece ₹
M36/01	125	35.00
M36/02	150	45.00
M36/03	200	65.00
M36/04	250	90.00
M36/05	300	120.00



L-937

M37- SPATULA MICRO, Made of S. S. Rod with flat blade at one side and micro spoon type at other end

HSN Code : 9027

CAT No.	Size mm (Spoon)	Price / Piece ₹
M37/01	125	40.00
M37/02	150	50.00
M37/03	200	60.00
M37/04	250	90.00
M37/05	300	120.00

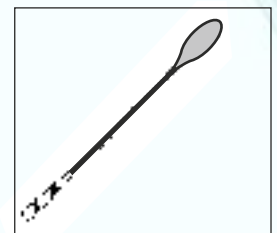

L-938

M38- CLIP, for spherical Ball and Socket Joints.

HSN Code : 7107

CAT No.	Joint Size	Price / Piece ₹
M38/01	S-13	125.00
M38/02	S-19	150.00
M38/03	S-29	185.00
M38/04	S-35	225.00



L-968



RUBBERWARE

Essential to Science

Explore, Experiment, Excel



**YOUR TRUSTED PARTNER FOR SCIENTIFIC LAB
GLASSWARE, EQUIPMENTS & CONSUMABLES**

R01- PIPETTE BULB, Rubber Red Colour

HSN Code : 4016

CAT No.	Pipette Capacity ml	Price / Piece ₹
R01/01	1 to 5	22.00
R01/02	10	30.00
R01/03	15	35.00
R01/04	20	45.00
R01/05	50	100.00
R01/06	100	120.00
R01/07	25 Oval Shape	80.00



L-988

R02- PIPETTE BULB, SILICON Rubber NEW

HSN Code : 4016

CAT No.	Pipette Capacity ml	Price / Piece ₹
R02/01	5	55.00
R02/02	10	75.00
R02/03	15	95.00
R02/04	25 Oval Shape	155.00
R02/05	20	110.00
R02/06	50	280.00
R02/07	100	350.00



L-989

R03- RUBBER BELLOWS, With bulb and bladder which acts as reservoir. It is covered with cotton net to prevent over expansion. This is known as double bellows.

HSN Code : 4016

CAT No.	Size ml	Price / Piece ₹
Without Non Return Valve		
R03/01	250	370.00
R03/02	500	410.00
R03/03	Medium 1000	620.00
R03/04	Large 2000	845.00
With Non Return Valve		
R03/11	250	470.00
R03/12	500	530.00
R03/13	Medium 1000	850.00
R03/14	Large 2000	1200.00

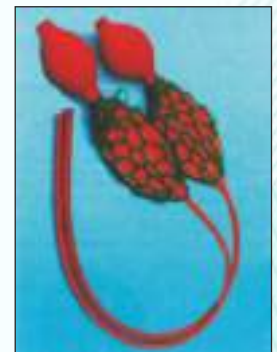

L-992

R04- GAS BLADDERS Made of Rubber (Latex) with nozzle for Gas Collection, Spoils on long storage not replaceable keep in cool dry place.

HSN Code : 9506

CAT No.	Size	Price / Piece ₹
R04/01	5	500.00



L-994

R05- RUBBER TUBING LIGHT WALL FOR CONDENSER, fine red colour extra soft and strong. suitable for general laboratory application. Available in 10 mtr Roll.

HSN Code : 4009

CAT No.	Bore mm	Wall Thickness mm	Price / 10 Mtr. Roll ₹
R05/01	4.0	1.0	450.00
R05/02	5.0	1.5	525.00
R05/03	6.0	1.5	600.00
R05/04	7.0	1.5	680.00
R05/05	8.0	2.0	750.00
R05/06	10.0	2.4	1100.00
R05/07	12.0	2.4	1400.00
R05/08	9.0	2.0	850.00



L-1001

R06- PRESSURE NEOPRENE RUBBER TUBING (L. P. G.) green colour, Made of synthetic neoprene rubber, for high pressure liquid petroleum gas.

HSN Code : 4009

CAT No.	ID mm	Wall Thickness mm	Price / 10 Mtr. Roll ₹
R06/01	NON ISI 8.0	3.0	950.00
R06/02	NON ISI 10.0	3.0	1200.00



L-1002

R07- Rubber Bulbs, Natural for Pasteur Pipettes

Catalog Number	Description	Capacity	Hole Size	Lenght	O.D	Pack Size	Price/ Piece ₹
R07/01	Rubber Bulb	1 mL	5mm	43mm	13mm	10	20.00
R07/02	Rubber Bulb	2 mL	6mm	52mm	13mm	10	30.00



R08- Filter Adapters

Catalog Number	Description	Height	I.D top *I.D bottom	O.D top O.D bottom	Wall Thickness	Price/ Piece ₹
R08/01	Filter adapters full set-size 1 to 7	n/a mm	n/a mm	n/a mm	n/a mm	1180.00
R08/02	Filter adapter , size 1	21mm	17 x 7 mm	21 x 11 mm	2.0mm	98.00
R08/03	Filter adapter , size 2	21mm	22 x 11 mm	27 x 16 mm	2.5mm	140.00
R08/04	Filter adapter , size 3	25mm	31 x 16 mm	37 x 22 mm	3.0mm	150.00
R08/05	Filter adapter , size 4	29mm	39 x 22 mm	46 x 29 mm	3.5mm	165.00
R08/06	Filter adapter , size 5	35mm	50 x 30 mm	58 x 38 mm	4.0mm	185.00
R08/07	Filter adapter , size 6	40mm	60 x 36 mm	69 x 45 mm	4.5mm	215.00
R08/08	Filter adapter , size 7	45mm	75 x 46 mm	86 x 57 mm	5.5mm	245.00



R09- Rubber Stopper

Catalog Number	Stopper Size	Top Dia	Lenght	Bottom Dia	Price/ Piece ₹
R09/01	0	13 mm	15.5 mm	9 mm	40.00
R09/02	00	10 mm	16 mm	7 mm	30.00
R09/03	000	9 mm	16 mm	6 mm	28.00
R09/04	1	14 mm	18.5 mm	11 mm	48.00
R09/05	2	16.5 mm	20 mm	13 mm	60.00
R09/06	3	19 mm	21 mm	14 mm	70.00
R09/07	4	21 mm	22 mm	15 mm	75.00
R09/08	5	22.5 mm	23 mm	17 mm	85.00
R09/09	6	24.5 mm	24 mm	20.5 mm	115.00
R09/10	7	26 mm	27.5 mm	20 mm	135.00
R09/11	8	26.5 mm	27.5 mm	21 mm	160.00
R09/12	9	28 mm	31 mm	21.5 mm	210.00
R09/13	10	30 mm	33 mm	26 mm	250.00
R09/14	11	32.5 mm	32.5 mm	28.5 mm	290.00
R09/15	12	34.5 mm	34.5 mm	30 mm	350.00
R09/16	13	38.5 mm	37 mm	31 mm	450.00



R10- Rubber Stopper, with 1 hole

Catalog Number	Stopper Size	Top Dia	Lenght	Bottom Dia	Price/ Piece ₹
R09/01	0	13 mm	15.5 mm	9 mm	90.00
R09/02	00	10 mm	16 mm	7 mm	80.00
R09/03	000	9 mm	16 mm	6 mm	78.00
R09/04	1	14 mm	18.5 mm	11 mm	98.00
R09/05	2	16.5 mm	20 mm	13 mm	110.00
R09/06	3	19 mm	21 mm	14 mm	120.00
R09/07	4	21 mm	22 mm	15 mm	125.00
R09/08	5	22.5 mm	23 mm	17 mm	135.00
R09/09	6	24.5 mm	24 mm	20.5 mm	165.00
R09/10	7	26 mm	27.5 mm	20 mm	185.00
R09/11	8	26.5 mm	27.5 mm	21 mm	210.00
R09/12	9	28 mm	31 mm	21.5 mm	260.00
R09/13	10	30 mm	33 mm	26 mm	310.00
R09/14	11	32.5 mm	32.5 mm	28.5 mm	340.00
R09/15	12	34.5 mm	34.5 mm	30 mm	390.00
R09/16	13	38.5 mm	37 mm	31 mm	500.00



Note - Hole diameter : 5 - 8 mm

R11- Rubber Stopper, with 2 hole

Catalog Number	Stopper Size	Top Dia	Lenght	Bottom Dia	Price/ Piece ₹
R11/01	0	13 mm	15.5 mm	9 mm	120.00
R11/02	00	10 mm	16 mm	7 mm	130.00
R11/03	000	9 mm	16 mm	6 mm	130.00
R11/04	1	14 mm	18.5 mm	11 mm	150.00
R11/05	2	16.5 mm	20 mm	13 mm	160.00
R11/06	3	19 mm	21 mm	14 mm	170.00
R11/07	4	21 mm	22 mm	15 mm	175.00
R11/08	5	22.5 mm	23 mm	17 mm	185.00
R11/09	6	24.5 mm	24 mm	20.5 mm	215.00
R11/10	7	26 mm	27.5 mm	20 mm	245.00
R11/11	8	26.5 mm	27.5 mm	21 mm	260.00
R11/12	9	28 mm	31 mm	21.5 mm	310.00
R11/13	10	30 mm	33 mm	26 mm	360.00
R11/14	11	32.5 mm	32.5 mm	28.5 mm	400.00
R11/15	12	34.5 mm	34.5 mm	30 mm	450.00
R11/16	13	38.5 mm	37 mm	31 mm	550.00

Note - Hole diameter : 5 - 8 mm





PORCELAINWARE

Essential to Science

Explore, Experiment, Excel



**YOUR TRUSTED PARTNER FOR SCIENTIFIC LAB
GLASSWARE, EQUIPMENTS & CONSUMABLES**

PW01- PORCELAIN CRUCIBLE, TALL FORM WITH LID

Product Code	Capacity (ml)	Price/ Piece ₹
PW01/01	1.3	15.00
PW01/02	5	18.00
PW01/03	10	21.00
PW01/04	15	24.00
PW01/05	25	32.00
PW01/06	30	35.00
PW01/07	40	45.00
PW01/08	50	52.00
PW01/09	60	56.00
PW01/10	90	61.00
PW01/11	100	68.00
PW01/12	150	88.00
PW01/13	250	112.00



PW02- PORCELAIN CRUCIBLE, WIDE FORM WITH LID

Product Code	Capacity (ml)	Price/ Piece ₹
PW02/01	2	15.00
PW02/02	5	16.00
PW02/03	8	18.00
PW02/04	17	25.00
PW02/05	30	35.00
PW02/06	50	52.00
PW02/07	75	61.00
PW02/08	100	72.00
PW02/09	150	80.00
PW02/10	250	104.00
PW02/11	500	144.00



PW03- PORCELAIN CRUCIBLE COVER

Product Code	Product Description	Price/ Piece ₹
PW03/01	26 mm	8.00
PW03/02	34mm	8.00
PW03/03	38mm	8.00
PW03/04	47mm	12.00
PW03/05	53mm	12.00
PW03/06	58mm	15.00
PW03/07	69mm	21.00
PW03/08	80mm	21.00
PW03/09	93mm	29.00
PW03/10	100mm	32.00
PW03/11	155mm	48.00



PW04- PORCELAIN BITUMEN CRUCIBLE

Product Code	Capacity (ml)	Filter Paper Dia(mm)	Price/ Piece ₹
PW04/01	28	30-33	30.00



PW05- PORCELAIN CASSEROLE

Product Code	Capacity (ml)	Price/ Piece ₹
PW05/01	25	42.00
PW05/02	35	53.00
PW05/03	65	56.00
PW05/04	85	72.00
PW05/05	140	87.00
PW05/06	200	112.00
PW05/07	300	152.00
PW05/08	400	200.00
PW05/09	500	224.00
PW05/10	760	256.00
PW05/11	1250	368.00



PW06- PORCELAIN GOOCH CRUCIBLE

Product Code	Capacity (ml)	Price/ Piece ₹
PW06/01	15	26.00
PW06/02	17	29.00
PW06/03	20	40.00
PW06/04	30	48.00
PW06/05	35	50.00
PW06/06	50	80.00
PW06/07	140	96.00



PW07- PORCELAIN BITUMEN CRUCIBLE

Product Code	Capacity (ml)	Price/ Piece ₹
PW07/01	70	30.00



PW08- PORCELAIN EVAPORATING BASIN, ROUND BOTTOM

Product Code	Capacity (ml)	Top Outer Dia (mm)	Price/ Piece ₹
PW08/01	35	60	32.00
PW08/02	70	75	37.00
PW08/03	80	80	42.00
PW08/04	120	94	43.00
PW08/05	150	100	51.00
PW08/06	250	115	100.00
PW08/07	385	145	120.00
PW08/08	420	150	176.00
PW08/09	525	162	202.00
PW08/10	765	185	352.00
PW08/11	850	190	440.00
PW08/12	1000	200	480.00
PW08/13	1285	215	552.00
PW08/14	2100	265	704.00
PW08/15	3250	305	1648.00
PW08/16	5000	355	2800.00
PW08/17	8500	400	7760.00



PW09- PORCELAIN EVAPORATING BASIN, FLAT BOTTOM

Product Code	Capacity (ml)	Top Outer Dia (mm)	Price/ Piece ₹
PW09/01	10	50	23.00
PW09/02	30	60	26.00
PW09/03	35	65	31.00
PW09/04	50	75	32.00
PW09/05	80	85	37.00
PW09/06	100	77	45.00
PW09/07	100	100	48.00
PW09/08	200	120	61.00
PW09/09	300	150	144.00
PW09/10	500	175	208.00
PW09/11	1000	200	308.00
PW09/12	1500	250	704.00
PW09/13	2000	300	1520.00



PW10- PORCELAIN TABLE FILTER FUNNEL

Product Code	Length (mm)	Price/ Piece ₹
PW10/01	60	8.00
PW10/02	86	10.00
PW10/03	100	12.00



PW11- PORCELAIN EVAPORATING BASIN (REGULAR)

Product Code	Capacity (ml)	Top Outer Dia (mm)	Price/ Piece ₹
PW11/01	4	28	23.00
PW11/02	10	40	24.00
PW11/03	20	50	26.00
PW11/04	40	60	29.00
PW11/05	100	75	34.00
PW11/06	125	85	35.00
PW11/07	175	100	50.00
PW11/08	250	110	64.00
PW11/09	400	125	112.00
PW11/10	550	140	116.00
PW11/11	800	150	160.00
PW11/12	1300	175	264.00
PW11/13	1800	200	496.00
PW11/14	3300	250	816.00
PW11/15	4500	300	1632.00
PW11/16	7500	350	2816.00
PW11/17	11000	350	4240.00
PW11/18	14000	400	7840.00
PW11/19	16000	450	8880.00
PW11/20	18000	500	11520.00



PW12- PORCELAIN MORTAR & PESTLE

Product Code	Top ID (mm)	Top Outer Dia (mm)	Capacity (ml)	Price/ Piece ₹
PW12/01	60	80	60	53.00
PW12/02	75	90	100	70.00
PW12/03	85	105	150	85.00
PW12/04	100	125	275	145.00
PW12/05	125	155	500	232.00
PW12/06	150	180	900	305.00
PW12/07	175	200	1500	560.00
PW12/08	200	230	2000	680.00
PW12/09	250	285	4200	2160.00
PW12/10	300	330	7000	3280.00
PW12/11	350	400		7360.00
PW12/12	400	450		11400.00



PW13- PORCELAIN GOOCH CRUCIBLE

Product Code	Top OD (mm)	Price/ Piece ₹
PW13/01	30	53.00
PW13/02	42	60.00
PW13/03	50	65.00
PW13/04	55	72.00
PW13/05	78	110.00
PW13/06	95	120.00



PW14- PORCELAIN MORTAR (AMERICAN DESIGN)

Product Code	Top ID (mm)	Top Outer Dia (mm)	Capacity (ml)	Price/ Piece ₹
PW14/01	55	70	50	36.00
PW14/02	64	80	65	44.00
PW14/03	72	90	145	64.00
PW14/04	92	115	275	96.00
PW14/05	107	130	400	160.00
PW14/06	134	163	750	200.00
PW14/07	156	186	1100	320.00
PW14/08	180	210	1900	400.00
PW14/09	215	256	2750	1280.00
PW14/10	242	283	4000	1350.00



PW15- PORCELAIN PESTLE

Product Code	Product Description	Price/ Piece ₹
PW15/01	98 mm	24.00
PW15/02	114 mm	32.00
PW15/03	130 mm	42.00
PW15/04	157 mm	56.00
PW15/05	180 mm	56.00
PW15/06	194 mm	64.00
PW15/07	222 mm	72.00
PW15/08	262 mm	128.00
PW15/09	280 mm	144.00
PW15/10	300 mm	180.00



PW16- PORCELAIN SPATULA WITH SPOON

Product Code	Length (mm)	Price/ Piece ₹
PW16/01	100	40.00
PW16/02	125	44.00
PW16/03	145	48.00
PW16/04	165	53.00
PW16/05	198	84.00
PW16/06	220	96.00
PW16/07	260	104.00



PW17- PORCELAIN SPATULA

Product Code	Length (mm)	Price/ Piece ₹
PW17/01	205	80.00



PW18- CLAY PIPE TRIANGLE WITH STAINLESS STEEL WIRE

Product Code	Size (mm)	Price/ Piece ₹
PW18/01	50	39.00
PW18/02	60	42.00
PW18/03	75	45.00



PW19- PORCELAIN FILTER DISC

Product Code	Diameter (mm)	Price/ Piece ₹
PW19/01	12	16.00
PW19/02	22	20.00
PW19/03	25	23.00



PW20- PORCELAIN NETI POT

Product Code	Capacity (ml)	Price/ Piece ₹
PW20/01	12	68.00
PW20/02	22	68.00
PW20/03	25	72.00



PW21- PORCELAIN INHALER DR. NELSON'S TYPE

Product Code	Capacity (ml)	Price/ Piece ₹
PW21/01	500 Without cork & Tube	120.00
PW21/02	750 Without cork & Tube	128.00
PW21/03	500 Without cork & Tube	176.00
PW21/04	750 Without cork & Tube	184.00



PW22- PORCELAIN FEEDING CUP

Product Code	Capacity (ml)	Price/ Piece ₹
PW22/01	180	53.00
PW22/02	210	56.00
PW22/03	250	63.00



PW23- PORCELAIN POT MILL

Product Code	Capacity (ltr)	Price/ Piece ₹
PW23/01	2	1600.00
PW23/02	7	2120.00
PW23/03	10	2512.00



PW24- PORCELAIN MERCURY TROUGHS

Product Code	Capacity (ml)	Price/ Piece ₹
PW24/01	100	96.00



PW25- PORCELAIN TROUGHS

Product Code	Top Outer Dia (mm)	Price/ Piece ₹
PW25/01	100	160.00
PW25/02	150	224.00
PW25/03	200	456.00
PW25/04	250	688.00
PW25/05	300	976.00



PW26- PORCELAIN MOTH CRUSHER

Product Code	No. of cavities	Price/ Piece ₹
PW26/01	10	1120.00



PW27- PORCELAIN TILES, ACID PROOF

Product Code	Size (mm) (L x W x H)	Price/ Piece ₹
PW27/01	100 x 100 x 12	56.00
PW27/02	150 x 150 x 25	112.00

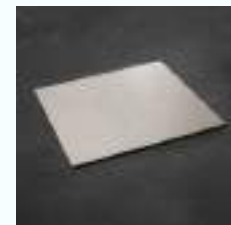

PW28- PORCELAIN POROUS PLATE

Product Code	Top Dia (mm)	Price/ Piece ₹
PW28/01	100	32.00
PW28/02	125	36.00
PW28/03	150	54.00



PW29- PORCELAIN POROUS POT

Product Code	Diameter x Length (mm)	Price/ Piece ₹
PW29/01	50 x 150	31.00
PW29/02	60 x 150	37.00
PW29/03	75 x 150	43.00



PW30- PORCELAIN POROUS SLAB/TILES

Product Code	Length x Width (mm)	Price/ Piece ₹
PW30/01	100 x 100	80.00
PW30/02	150 x 150	112.00



PW31- PORCELAIN POROUS CRUCIBLE

Product Code	Capacity (ml)	Approx. Pore Dia (mm)	Price/ Piece ₹
PW31/01	25	1.2 Microns	320.00
PW31/02	25	5.0 Microns	320.00
PW31/03	25	15 Microns	320.00



SC01- CRUCIBLE FUSED SILICA REGULAR FORM

Product Code	Capacity (ml)	Packing	Price/ Piece ₹
SC01/01	15	36	378.00
SC01/02	25	30	392.00
SC01/03	50	20	700.00
SC01/04	80	6	1065.00
SC01/05	100	6	1235.00
SC01/06	150	5	1540.00
SC01/07	250	3	2100.00



SC02- CRUCIBLE FUSED SILICA TALL FORM

Product Code	Capacity (ml)	Packing	Price/ Piece ₹
SC02/01	15	30	405.00
SC02/02	30	20	590.00
SC02/03	50	15	840.00



SC03- CRUCIBLE FUSED SILICA REGULAR FORM

Product Code	Capacity (ml)	Packing	Price/ Piece ₹
SC03/01	15	36	380.00
SC03/02	25	30	395.00
SC03/03	50	20	675.00
SC03/04	80	12	1050.00
SC03/05	100	12	1235.00
SC03/06	150	6	1540.00
SC03/07	250	6	2100.00



SC04- GOOCH CRUCIBLE FUSED SILICA

Product Code	Capacity (ml)	Packing	Price/ Piece ₹
SC04/01	20	25	980.00
SC04/02	30	20	1330.00
SC04/03	50	15	1680.00



SC05- COOKING CRUCIBLE FUSED SILICA VOLATILE MATTER DETERMINATION

Product Code	Details	Packing	Price/ Piece ₹
SC05/01	Crucible	10	730.00
SC05/02	Lid	10	280.00
SC05/03	Plunger	10	490.00



SC06- BASINS (EVAPORATING DISHES) WITH SPOUT FUSED SILICA

Product Code	Capacity (ml)	Dia (mm)	Packing	Price/ Piece ₹
SC06/01	20	48-52	12	420.00
SC06/02	35	55-60	12	588.00
SC06/03	70	70-75	8	1008.00
SC06/04	100	80-85	6	1235.00
SC06/05	150	90-95	6	1540.00
SC06/06	200	98-103	6	1960.00
SC06/07	250	107-110	5	2100.00

SC07- MUFFLE STAND QUARTZ SILICA THIASIL

Product Code	Capacity (ml)	Packing	Price/ Piece ₹
SC07/01	For 2 V.M Crucible (2 Holes)	5	1260.00
SC07/02	For 4 V.M Crucible (4 Holes)	3	2240.00

SC08- CIRCULAR CAPSULES QUARTZ SILICA

Product Code	Dia (mm)	Capacity (ml)	HT (mm)	Packing	Price/ Piece ₹
SC08/01	40	10	15	20	590.00
SC08/02	48	20	15	20	730.00
SC08/03	54	25	15	20	840.00

SC09- CIRCULAR CAPSULES WITH GROUND LID FOR MOISTURE & ASH DETERMINATION QUARTZ SILICA

Product Code	Dia (mm)	HT (mm)	Packing	Price/ Piece ₹
SC09/01	38	11	12	1120.00
SC09/02	54	11	12	1400.00

SC10- TRIANGLES ON NICHROME WIRE FUSED SILICA THIASIL

Product Code	Length (mm)	Packing	Price/ Piece ₹
SC10/01	38	10	280.00
SC10/02	50	10	310.00
SC10/03	63	10	350.00
SC10/04	75	10	395.00
SC10/05	100	10	475.00

SC11- CIRCULAR CAPSULES QUARTZ SILICA THIASIL

Product Code	Length (mm)	Wid (mm)	HT (mm)	Packing	Price/ Piece ₹
SC11/01	50	12	8	10	490.00
SC11/02	70	12	8	10	560.00
SC11/03	78	20	12	10	785.00
SC11/04	103	20	12	10	925.00





How To Use

What should I pay attention to when I use Alumina products?

- Alumina products are fragile. Please handle them carefully and avoid collision during unpacking, transportation, handling and cleaning.
- Check whether any micro-cracks exist before using Alumina products. Products with micro-cracks should not be used.
- Do not load too many materials in Alumina crucibles, which can increase the possibility of uneven heating.
- Slow ramp rate and cooling rate are highly recommended to minimize the thermal shock on crucibles. The rate can be faster in other temperature ranges, but it is recommended to be less than 5°C /MIN.
- To take the crucible directly out of furnace at high temperature may cause crack. If possible, take it out when the temperature is under 100°C.
- Alumina crucibles should not be heated by torch or furnaces that cannot control temperature change rate. The uneven heating can cause crack.

Heating and Cooling Instructions

- Alumina is sensitive to thermal shock. Try to warm up the furnace chamber slowly. Heating rate of 150-300°C per hour is recommended for the first 1-1.5 hours to reduce the impact of thermal shock. Lower the temperature as gradually as possible.
- It is recommended to keep at least 50 mm distance from the heating elements. Not having adequate space between your crucible and top and sides of your furnace may lead to cracking when the crucibles expands on heating.
- Large crucibles may need some preheating to overcome the possibility cracking due to thermal shock. We recommend placing your crucibles on top of a substrate plate of same material to reduce the risk of thermal shock. We recommend a heating rate of 150°C/ hr so that the Large crucibles can be evenly heated.
- Lower the temperature as gradually as possible. The cooling down rate is often half of the heating rate. Avoid contact of heated alumina products with a cold surface.
- Maximum Temperature Limit for Alumina Al₂O₃ Crucibles is 1600°C

PROPERTIES OF ALUMINA LAB WARES

S.No	Characteristics	Value
1	Principal Constituent Al ₂ O ₃ Purity	>99.9% Al ₂ O ₃
2	Tolerance	+/-2%
3	Sintering Additives	Nil
4	Appearance	Pearl White
5	It is optically transparent in the near-ultraviolet, visible and infrared regions	Nil
6	Apparent Density	>3.89 g/cc
7	Grain Size	~10 m
8	Open Porosity	Nil
9	Hardness (knoop 100g)	23000 Mpa
10	Compressive Strength	3500 Mpa
11	Bending Strength	300 Mpa
12	Modulus of Elasticity	380 Gpa
13	Melting Point	2030 °C
14	Maximum Working Temperature	1800 °C
15	Specific Heat	900 J/KgK
16	Thermal Conductivity at 100 °C	30 W/mK
17	Thermal Conductivity at 1000 °C	5 W/mK
18	Coefficient of Linear Expansion between 0-1000 °C	~8.5 x 10 ⁻⁶ /K
19	Emissivity at 1000 °C	~21%
20	Surface Finish	3 triangles or better
21	Dielectric Constant	9.8

AW01- 99.9% ALUMINA CYLINDRICAL SHAPE CRUCIBLES

PRODUCT CODE	OD (MM)	ID (MM)	HEIGHT (MM)	VOLUME (CC)	WITHOUT LID PRICE (₹)	WITH LID PRICE (₹)
AW01/01	20	15	30	5	540	698
AW01/02	25	20	25	10	630	720
AW01/03	30	25	30	15	675	810
AW01/04	30	25	40	20	720	938
AW01/05	30	25	50	25	765	990
AW01/06	35	30	45	30	810	1080
AW01/07	40	35	50	40	900	1238
AW01/08	40	35	52	50	1080	1380
AW01/09	40	35	62	60	1170	1552
AW01/10	40	35	73	70	1245	1665
AW01/11	50	45	55	80	1350	1740
AW01/12	50	45	57	90	1440	1800
AW01/13	50	45	63	100	1530	1875
AW01/14	50	45	75	120	1800	2100
AW01/15	55	50	85	150	2250	2550
AW01/16	66	57	87	200	2700	3000
AW01/17	68	58	107	250	2970	3450
AW01/18	65	60	106	300	3105	3780
AW01/19	100	95	70	500	5580	6300
AW01/20	100	95	100	600	6300	7920
AW01/21	100	90	170	1000	10800	12600



AW02- 99.9% BOWL SHAPED ALUMINA CRUCIBLES

PRODUCT CODE	TOP OD (MM)	BOTTOM OD (MM)	HEIGHT (MM)	VOLUME (CC)	WITH OUT LID PRICE (₹)	WITH LID PRICE (₹)
AW02/01	30	20	35	10	540	720
AW02/02	36	23	48	20	720	900
AW02/03	38	25	60	30	810	1080
AW02/04	48	30	70	50	990	1350
AW02/05	59	40	80	100	1530	2160
AW02/06	67	50	78	195	2160	2880
AW02/07	73	55	86	255	2700	3600
AW02/08	78	60	96	310	3600	4860
AW02/09	90	65	90	300	3960	5400
AW02/10	95	70	95	350	4500	6300
AW02/11	85	75	115	500	6840	7560
AW02/12	115	105	140	1000	10800	12600



AW03- 99.9% LOW FORM ALUMINA CRUCIBLES

PRODUCT CODE	TOP OD (MM)	BOTTOM OD (MM)	HEIGHT (MM)	VOLUME (CC)	WITHOUT LID PRICE (₹)	WITH LID PRICE (₹)
AW03/01	40	25	25	10	563	990
AW03/02	50	20	35	20	780	1320
AW03/03	45	20	35	25	900	1387
AW03/04	55	25	40	30	915	1425
AW03/05	60	30	45	50	1120	1620
AW03/06	65	35	55	80	1387	1950
AW03/07	80	35	50	170	2340	3277
AW03/08	85	50	60	220	3060	4320



AW04- 99.9% CONICAL ALUMINA CRUCIBLES

PRODUCT CODE	TOP OD (MM)	BOTTOM OD (MM)	HEIGHT (MM)	VOLUME (CC)	WITHOUT LID PRICE (₹)	WITH LID PRICE (₹)
AW04/01	36	28	18	10	450	630
AW04/02	34	24	36	15	480	720
AW04/03	32	25	42	20	720	900
AW04/04	38	26	46	25	810	1080
AW04/05	41	34	45	30	990	1350
AW04/06	43	35	56	50	1120	1510
AW04/07	65	30	85	100	1710	2250
AW04/08	62	35	90	150	2160	3420
AW04/09	80	60	60	170	2700	4050
AW04/10	70	40	95	200	3330	4860
AW04/11	80	45	100	250	3600	6300
AW04/12	85	62	125	500	6300	6840



AW05- 99.9% ALUMINA BOATS

PRODUCT CODE	LENGTH (MM)	WIDTH (MM)	HEIGHT (MM)	VOLUME (CC)	PRICE (₹)
AW05/01	80	8	8	2	450
AW05/02	86	15	13	7	630
AW05/03	100	10	10	5	540
AW05/04	40	25	25	10	720
AW05/05	45	25	20	10	720
AW05/06	50	20	20	10	720
AW05/07	100	15	20	15	810
AW05/08	100	20	20	20	990
AW05/09	100	25	25	30	1170
AW05/10	100	30	35	40	1350
AW05/11	120	30	20	55	1530
AW05/12	135	30	25	55	1530
AW05/13	250	50	100	1000	24300



AW06- 99.9% SEMI CIRCULAR ALUMINA BOAT

PRODUCT CODE	WIDTH (MM)	LENGTH (MM)	VOLUME (CC)	PRICE (₹)
AW06/01	40	100	60	1350
AW06/02	50	100	100	1620
AW06/03	70	100	200	3240



AW07- 99.9% ALUMINA TRAYS

PRODUCT CODE	LENGTH (MM)	WIDTH (MM)	HEIGHT (MM)	VOLUME (CC)	PRICE (₹)
AW07/01	10	10	5	0.2	540
AW07/02	75	25	10	10	810
AW07/03	50	25	10	10	810
AW07/04	50	25	20	20	990
AW07/05	50	50	20	40	1080
AW07/06	100	40	20	50	1350
AW07/07	100	45	20	90	1800
AW07/08	100	50	30	100	2340
AW07/09	125	40	25	100	2700
AW07/10	125	65	25	120	3600
AW07/11	130	60	25	130	4500
AW07/12	120	120	20	160	5400
AW07/13	130	50	40	230	6750
AW07/14	100	100	40	250	8100
AW07/15	200	90	25	340	9000
AW07/16	250	160	40	1000	18900



AW08- 99.9% ALUMINA DISH

PRODUCT CODE	DIAMETER (MM)	HEIGHT (MM)	VOLUME (CC)	PRICE (₹)
AW08/01	35	10	5	270
AW08/02	40	7	7	360
AW08/03	38	28	10	450
AW08/04	40	10	10	540
AW08/05	50	15	20	720
AW08/06	60	20	40	990
AW08/07	75	32	100	1460
AW08/08	65	45	110	1800
AW08/08	100	45	250	2700



AW09- 99.9% ALUMINA DISC

PRODUCT CODE	DIAMETER (MM)	THICKNESS (MM)	PRICE (₹)
AW09/01	10	3	180
AW09/02	15	3	270
AW09/03	20	3	360
AW09/04	25	3	450
AW09/05	30	3	540
AW09/06	35	3	630
AW09/07	40	3	720
AW09/08	45	3	810
AW09/09	50	3	900
AW09/10	55	3	990
AW09/11	60	3	1080
AW09/12	75	3	1170
AW09/13	80	3	1260
AW09/14	90	3	1350
AW09/15	100	3	1018



AW10- 99.9% ALUMINA PLATE

PRODUCT CODE	LENGTH (MM)	WIDTH (MM)	THICKNESS (MM)	PRICE (₹)
AW10/01	10	10	3	270
AW10/02	20	20	3	360
AW10/03	50	25	3	540
AW10/04	50	50	3	720
AW10/05	60	30	3	810
AW10/06	80	40	3	900
AW10/07	100	25	3	1080
AW10/08	110	50	3	1350
AW10/09	115	55	3	1626
AW10/10	120	60	3	1800
AW10/11	100	100	3	2700



AW11- 99.9% ALUMINA SUBSTRATE

PRODUCT CODE	LENGTH (MM)	WIDTH (MM)	THICKNESS (MM)	PRICE (₹)
AW11/01	10	10	0.5	810
AW11/02	10	10	1	720
AW11/03	20	20	0.5	1626
AW11/04	20	20	1	1350
AW11/05	25	25	0.5	1800
AW11/06	25	25	1	1626
AW11/07	50	50	0.5	3240
AW11/08	50	50	1	2700



AW12- 99.8 % RECRYSTALLIZED ALUMINA TUBE

PRODUCT CODE	OD (MM)	ID (MM)	LENGTH (MM)	PRICE (₹)
AW12/01	50	40	1000	48600
AW12/02	60	50	1000	63000
AW12/03	70	60	1000	74700
AW12/04	80	70	1000	90000
AW12/05	90	80	1000	990000
AW12/06	100	90	1000	117000
AW12/07	110	100	1000	126000

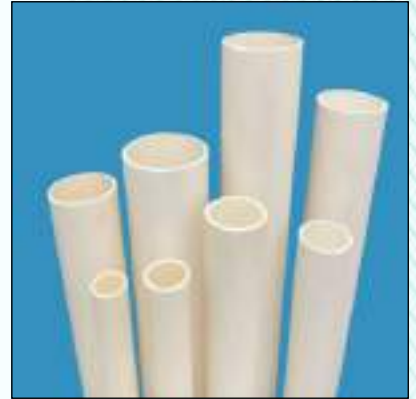

PROPERTIES OF ZIRCONIA WARES

Bulk Density	6 gm / cc
Working Temperature upto	2000 °C
Stabilization	8 mol % Ytria
Tolerance	+/-2%

Other Information about Zirconia

- Do not load too many materials in zirconia crucibles, which can increase the possibility of uneven heating.
- Slow ramp rate and cooling rate are highly recommended to minimize the thermal shock on crucibles. When increasing the temperature, special attention should be paid on two sensitive temperature periods: not exceeding 3 °C/MIN during 100 °C ~300 °C and 1050 °C ~ 1200 °C. The rate can be faster in other temperature ranges, but it is recommended to be less than 5°C/ MIN.
- To take the crucible directly out of furnace at high temperature may cause crack. If possible, take it out when the temperature is under 100 °C.
- Zirconia crucibles should not be heated by torch or furnaces that cannot control temperature change rate. The uneven heating can cause crack.

ZW01- ZIRCONIA CRUCIBLES

PRODUCT CODE	OD (MM)	ID (MM)	HEIGHT (MM)	VOLUME (CC)	PRICE (₹)
ZW01/01	30	25	40	20	2700
ZW01/02	40	35	50	50	6300
ZW01/03	50	45	60	100	13500



ZW02- ZIRCONIA BOATS

PRODUCT CODE	LENGTH (MM)	WIDTH (MM)	HEIGHT (MM)	VOLUME (CC)	PRICE (₹)
ZW02/01	40	25	20	10	2700
ZW02/02	100	20	20	20	5400



ZW03- ZIRCONIA DISC

PRODUCT CODE	DIAMETER (MM)	THICKNESS (MM)	PRICE (₹)
ZW03/01	10	3	1800
ZW03/02	20	3	2160
ZW03/03	50	3	4500
ZW03/04	80	3	6000
ZW03/05	100	3	10200



ZW04- ZIRCONIA PLATE

PRODUCT CODE	LENGTH (MM)	WIDTH (MM)	THICKNESS (MM)	PRICE (₹)
ZW04/01	10	10	3	2160
ZW04/02	25	25	3	4500
ZW04/03	50	50	3	5400
ZW04/04	100	100	3	7200

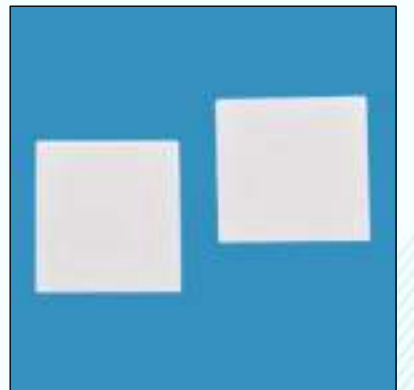

PROPERTIES OF AGATE WARES

S.No	Composition	Weight (%)
1	SiO ₂	97.26
2	MgO/ CaO / Mn ₂ O ₃	2.74

PHYSICAL PROPERTIES OF AGATE WARES

S.No	Composition	Weight (%)
1	Specific Gravity	2.65 Kg/dm ³
2	Bulk Weight	1.5 KgL
3	Mohs Scale of Hardness	7.2 – 7.5
4	Modulus of Elasticity	>70 Gpa
5	Colour	Grey
6	Tolerance	+/- 5mm

AG01- AGATE MORTAR & PESTLE GREY

PRODUCT CODE	SIZE OD (INCH)	SIZE ID (INCH)	PRICE (₹)
AG01/01	2.5	2.0	4680
AG01/02	3.0	2.5	5760
AG01/03	3.5	3.0	7560
AG01/04	4.0	3.5	11700
AG01/05	4.5	4.0	13500
AG01/06	5.0	4.5	20700
AG01/07	5.5	5.0	32040
AG01/08	6.0	5.5	43920
AG01/09	6.5	6.0	64680

AG02- BLACK AGATE MORTAR & PESTLE

PRODUCT CODE	SIZE OD (INCH)	SIZE ID (INCH)	PRICE (₹)
AG02/01	2.5	2.0	1620
AG02/02	3.0	2.5	1800
AG02/03	3.5	3.0	2160
AG02/04	4.0	3.5	2700
AG02/05	4.5	4.0	3060
AG02/06	5.0	4.5	5760
AG02/07	5.5	5.0	7200
AG02/08	6.5	6.0	9900



PROPERTIES OF QUARTZ WARES

Clear fused quartz glass is a unique material with an unrivalled combination of purity, high temperature resistance, thermal shock resistance, high electrical insulation, optical transparency and chemical inertness.

Mechanical	
Density	$2.2 \times 10^3 \text{ Kg/m}^3$
Young's Modulus	$74 \times 10^6 \text{ KN/m}^2$
Rigidity Modulus	$32 \times 10^6 \text{ KN/m}^2$
Compressive Strength	$20 \times 10^6 \text{ KN/m}^2$
Tensile Strength	$70 \times 10^3 \text{ KN/m}^2$
Shear Strength	$70 \times 10^3 \text{ KN/m}^2$
Moh's Hardness	6

Electrical	
Electrical Resistivity	$2 \times 10^{19} \text{ ohm cm at } 20^\circ\text{C}$ $2 \times 10^6 \text{ ohm cm at } 800^\circ\text{C}$
Dielectric Strength	$10 \text{ KV/mm at } 20^\circ\text{C}$ $2.5 \text{ KV/mm at } 500^\circ\text{C}$

Thermal	
Strain Point	1385°K
Annealing Point	1455°K
Softening Point	1853°K
Coefficient of Expansion	$0.52 \times 10^{-6} \text{ per}^\circ\text{C}$
Cont. Operating Temp.	>1000°C

Optical	
Useful Optical Range	Synthetic 180 – 2000 nm Natural 275 – 2000 nm
Refractive Index	n D (589 nm) – 1.458

Chemical	
SiO ₂ Content	99.995%
Total Metallic Impurities	10 ppm (Typical)

Chemical Internes

Fused quartz does not react with exception of hydrofluoric and at high temperatures phosphoric. There is a slow reaction with caustic alkalies at normal temperatures. There is no reaction with water and steam at moderate temperature and pres

Q01- QUARTZ TALL FORM CRUCIBLES

PRODUCT CODE	OD (MM)	HEIGHT (MM)	VOLUME (CC)	WITH OUT LID PRICE (₹)	WITH LID PRICE (₹)
Q01/01	32	27	10	360	990
Q01/02	38	35	20	420	1350
Q01/03	39	43	30	540	1800
Q01/04	51	51	50	660	2160
Q01/05	81	73	200	1,020	2700



Q02- QUARTZ LOW FORM CRUCIBLES

PRODUCT CODE	OD (MM)	HEIGHT (MM)	VOLUME (CC)	WITH OUT LID PRICE (₹)	WITH LID PRICE (₹)
Q02/01	29	19	5	240	720
Q02/02	38	19	10	300	810
Q02/03	41	25	15	360	900
Q02/04	47	28	25	420	990
Q02/05	57	37	50	660	1440
Q02/06	67	45	80	1,200	2340
Q02/07	72	60	100	1,800	3060
Q02/08	82	51	150	2,400	4500



Q03- QUARTZ BOAT

PRODUCT CODE	LENGTH (MM)	WIDTH (MM)	HEIGHT (MM)	PRICE (₹)
Q03/01	49	15	9	720
Q03/02	77	12	10	900
Q03/03	77	17	11	1080
Q03/04	77	20	12	1260
Q03/05	103	20	12	1800



Q04- QUARTZ DISH

PRODUCT CODE	DIAMETER (MM)	HEIGHT (MM)	VOLUME (CC)	PRICE (₹)
Q04/01	40	15	10	1080
Q04/02	48	15	20	1260
Q04/03	54	15	25	1800



Q05- QUARTZ DISC

PRODUCT CODE	DIAMETER (MM)	THICKNESS (MM)	PRICE (₹)
Q05/01	25	1	1080
Q05/02	25	2	1080
Q05/03	25	3	1260
Q05/04	25	4	1530
Q05/05	25	5	1710
Q05/06	50	1	1800
Q05/07	50	2	1980
Q05/08	50	3	2340
Q05/09	50	4	2700
Q05/10	50	5	3240
Q05/11	75	1	3600
Q05/12	75	2	4500
Q05/13	75	3	5400
Q05/14	75	4	6300



Q06- QUARTZ PLATE

PRODUCT CODE	LENGTH (MM)	WIDTH (MM)	THICKNESS (MM)	PRICE (₹)
Q06/01	10	10	1	360
Q06/02	10	10	2	360
Q06/03	10	10	3	450
Q06/04	10	10	4	540
Q06/05	10	10	5	540
Q06/06	25	25	1	720
Q06/07	25	25	2	720
Q06/08	25	25	3	900
Q06/09	25	25	4	900
Q06/10	50	50	1	1800
Q06/11	50	50	2	2160
Q06/12	50	50	3	2160
Q06/13	50	50	4	2700
Q06/14	50	50	5	3600
Q06/15	75	75	1	5400
Q06/16	75	75	2	5400
Q06/17	75	75	3	6300
Q06/18	75	75	4	6300
Q06/19	75	25	1	2160
Q06/20	75	25	2	2385
Q06/21	75	25	3	2520
Q06/22	75	25	4	2700
Q06/23	75	25	5	2880
Q06/24	100	100	1	7200
Q06/25	100	100	2	8100
Q06/26	100	100	3	8100
Q06/27	100	100	4	9000
Q06/28	400	400	2	95400
Q06/29	400	400	3	100800
Q06/30	400	400	4	117000
Q06/31	400	400	5	126000

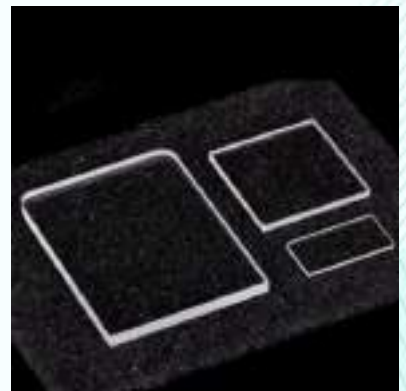

Q07- QUARTZ TUBE

PRODUCT CODE	OD (MM)	ID (MM)	LENGTH (MM)	PRICE (₹)
Q07/01	3	1	1200	180
Q07/02	4	2	1200	270
Q07/03	5	3	1200	270
Q07/04	6	4	1200	300
Q07/05	7	5	1200	320
Q07/06	8	5	1200	360
Q07/07	8	6	1200	375
Q07/08	9	7	1200	525
Q07/09	10	8	1200	540
Q07/10	11	9	1200	555
Q07/11	12	8	1200	990
Q07/12	12	10	1200	1080
Q07/13	13	11	1200	1125
Q07/14	15	12	1200	1125
Q07/15	16	13	1200	1350
Q07/16	18	14	1200	1800
Q07/17	19	15	1200	1873
Q07/18	19	16	1200	2160
Q07/19	20	17	1200	2175
Q07/20	20	18	1200	2250
Q07/21	22	19	1200	1725
Q07/22	23	20	1200	2355
Q07/23	24	21	1200	2400
Q07/24	25	19	1200	2438
Q07/25	25	21	1200	2610
Q07/26	25	22	1200	2625
Q07/27	28	25	1200	3300
Q07/28	30	25	1200	3600
Q07/29	30	27	1200	4320
Q07/30	32	27	1200	4860
Q07/31	33	30	1200	4950
Q07/32	35	30	1200	5400



Q08- SILICA LOW FORM CRUCIBLES AND LIDS

PRODUCT CODE	DIAMETER (MM)	HEIGHT (MM)	VOLUME (CC)	WITHOUT LID PRICE (₹)	WITH LID PRICE (₹)
Q08/01	41	25	15	240	720
Q08/02	47	28	25	360	900
Q08/03	57	37	50	480	1350
Q08/04	67	80	80	840	2520
Q08/05	71	50	100	1,080	3060
Q08/06	82	51	150	1,440	3600



Q09- SILICA TALL FORM CRUCIBLES AND LIDS

PRODUCT CODE	DIAMETER (MM)	HEIGHT (MM)	VOLUME (CC)	WITHOUT LID PRICE (₹)	WITH LID PRICE (₹)
Q09/01	43	39	30	480	1350
Q09/02	51	51	50	720	1800

Q10- QUARTZ TUBE

PRODUCT CODE	OD (MM)	ID (MM)	LENGTH (MM)	PRICE (₹)
Q10/01	35	32	1200	5475
Q10/02	38	35	1200	6300
Q10/03	40	35	1200	6375
Q10/04	45	40	1200	10800
Q10/05	50	45	1200	13500
Q10/06	55	50	1200	18000
Q10/07	60	55	1200	20700
Q10/08	65	60	1200	23400
Q10/09	70	65	1200	27000
Q10/10	75	70	1200	28800
Q10/11	80	75	1200	30600
Q10/12	85	80	1200	36000
Q10/13	90	85	1200	39600
Q10/14	95	90	1200	41400
Q10/15	100	95	1200	43200
Q10/16	105	100	1200	45000





LAB EQUIPMENTS

Essential to Science

Explore, Experiment, Excel



**YOUR TRUSTED PARTNER FOR SCIENTIFIC LAB
GLASSWARE, EQUIPMENTS & CONSUMABLES**

LE01- HEATING MANTLE SINGLE SIZE

Temperature Controlled Heating Mantle

Product Code	Capacity	Rating Watts	Circuits	Volts	Price Per Each ₹
LE01/01	50 MI	60	1	230	1550.00
LE01/02	100 MI	60	1	230	1625.00
LE01/03	250 MI	150	1	230	1700.00
LE01/04	500 MI	200	1	230	1800.00
LE01/05	1 Liter	300	1	230	2000.00
LE01/06	2 Liter	450	1	230	2400.00
LE01/07	3 Liter	450	1	230	2750.00
LE01/08	5 Liter	600	1	230	3450.00
LE01/09	10 Liter	2 x 500	2	230	6000.00
LE01/10	20 Liter	3 x 600	3	230	10,000.00
LE01/11	50 Liter	6 x 600	3	440	19,000.00
LE01/12	100 Liter	6 x 900	3	440	26,500.00
LE01/13	200 Liter	9 x 900	3	440	44,000.00



LE02- REPLACEMENTS ELEMENTS

Product Code	For single size heating mantle capacity	Price Per Each ₹
LE02/01	50 MI	450.00
LE02/02	100 MI	500.00
LE02/03	250 MI	550.00
LE02/04	500 MI	600.00
LE02/05	1 Liter	670.00
LE02/06	2 Liter	720.00
LE02/07	3 Liter	870.00
LE02/08	5 Liter	1080.00
LE02/09	10 Liter	3000.00
LE02/10	20 Liter	5000.00
LE02/11	50 Liter	12000.00
LE02/12	100 Liter	19000.00
LE02/13	200 Liter	23000.00



LE03- HEATING MANTLE MULTI SIZE / BOTTOM OUTLET

Product Code	Multi Size	Rating Watts	Volts	Price Per Each ₹
LE03/01	25 - 250 MI	150	230	1900.00
LE03/02	50 - 500 MI	200	230	2000.00
LE03/03	250 - 1 Liter	300	230	2200.00
LE03/04	250 - 2 Liter	350	230	2550.00
LE03/05	500 - 3 Liter	500	230	2900.00
LE03/06	1 - 5 Liter	600	230	3700.00
LE03/07	3 - 10 Liter	2 x 500	230	6000.00
LE03/08	3 - 20 Liter	3 x 600	230	10,000.00



LE04- CONTROL UNIT

Enlarging, Interchangeable Joints

Product Code	Description	Price Per Each ₹
LE04/01	With Receiving One Energy Regulator 5 Amp. X 15 Amp. Socket	800.00
LE04/02	With Receiving Tow Energy Regulator Two Lamp & Two Socket 5 & 15 Amp.	1500.00
LE04/03	With Receiving One Energy Regulator 5 Amp. X 15 Amp. Socket	2600.00

LE05- HEATING TAPES

Product Code	Length Inches Approx	Width Inches	Watts	Price Per Each ₹
LE05/01	24	1	60	500.00
LE05/02	36	1	90	650.00
LE05/03	48	1	120	800.00
LE05/04	60	1	150	950.00
LE05/05	72	1	180	1,050.00
LE05/06	24	2	120	650.00
LE05/07	36	2	180	750.00
LE05/08	48	2	240	900.00
LE05/09	60	2	300	1000.00
LE05/10	72	2	360	1200.00
LE05/11	260/- 250 Cms	25 mm	250	1750.00
LE05/12	510/- 500 Cms	25 mm	1000	3400.00



LE06- LABORATORY ELECTRIC HOT PLATES (ROUND)

Made Of Cast Iron, Body is of Thick Mild Steel

Product Code	Size Round	Rating	Regulator ₹	With Regulator & Three Heat ₹
LE06/01	4" Dia	300 Watts	2200.00	00.00
LE06/02	8" Dia	1.2 K.W.	4000.00	4300.00
LE06/03	9" Dia	1.5 K.W.	5250.00	5500.00
LE06/04	12" Dia	1.7 K.W.	6250.00	6500.00



LE07- LABORATORY ELECTRIC HOT PLATES (ROUND)

Made Of S.S (Plate in S.S) And S.S Body

Product Code	Size Round	Rating	With Regulator SS Top + MS Body	With Regulator & Three Heat SS Top + SS Body ₹
LE07/01	8" Dia	1.2 K.W.	6800.00	7800.00
LE07/02	9" Dia	1.5 K.W.	8800.00	9500.00
LE07/03	12" Dia	1.7 K.W.	10,500.00	13,000.00

Hot Plate With Digital Extra Cost RS. 5000.00

LE08 HOT PLATES RECTANGULAR

Thermostatically Controlled With energy regulator and 3 heat control switch only.

Product Code	Size	Watts	Plate In M . S. ₹	Plate In Stainless Steel ₹
LE08/01	12"x10" - 30cm x 25cm	1 K.W	6000.00	15,600.00
LE08/02	16"x10" - 40cm x 25cm	1.2 K.W.	7200.00	17,500.00
LE08/03	18"x12" - 45cm x 30cm	2 K.W.	11000.00	21,000.00
LE08/04	24"x18" - 60cm x 45cm	3 K.W.	20,500.00	39,000.00

Hot Plate With Digital Extra Cost RS. 5000.00



LE09 HOT PLATES (ELECTRIC) RECTANGULAR PLATE IN M.S.

Product Code	Size	Watts	With Regulator ₹
LE09/01	12"x10" - 30cm x 25cm	1 K.W	5800.00
LE09/02	16"x10" - 40cm x 25cm	1.2 K.W.	7000.00
LE09/03	18"x12" - 45cm x 30cm	2 K.W.	10,500.00
LE09/04	24"x18" - 60cm x 45cm	3 K.W.	20,000.00



LE10 BEAKER MANTLES

Surface Temperature up to 450 °C.

Product Code	Capacity	Watts	Price ₹
LE10/01	500 ML	200	2000.00
LE10/02	1 Liter	300	2300.00
LE10/03	2 Liter	450	3200.00
LE10/04	5 Liter	750	4800.00



LE11 WATER BATH ROUND (Thermostatics)

Double walled outside body MS, inside SS.

Product Code	Capacity	Watts	Price ₹	With Regulator, Digital Controller ₹
LE11/01	2 Liter	500	10,000.00	15000.00
LE11/02	5 Liter	1000	14,500.00	19,000.00



LE12 CARTRIDGE HEATER

Made from Nichrome 80 / 20 wire

Product Code	Capacity - Bath	Length	W	Watts	Price ₹
LE12/01	20 Liter	16"	45 mm	1500	1000.00
LE12/02	50 Liter	20"	45 mm	2000	1400.00
LE12/03	100 Liter	24"	45 mm	2500	1600.00
LE12/04	200 Liter	26"	45 mm	3000	1800.00



LE13 LABORATORY INCUBATOR

Incubator (For Temperature 37 °C To 60 °C) Thermostat Controlled

Product Code	Inner Size	No. of Sleeves	Watts	MS	SS
LE13/01	14" x 14" x 14"	2	300	17,500.00	24,000.00
LE13/02	18" x 18" x 18"	2	500	24,500.00	31,500.00



LE14 ELECTRIC BUNSEN BURNER

Product Code	Description	Price ₹
LE14/01	Overall height 6" cowl Dia. 2 1/2", Base Dia. 4 1/2"	4600.00
LE14/02	Spare heating element with ceramic crucible	1450.00



LE15 DRUM HEATER

Product Code	Description	Price ₹
LE15/01	Suitable for 45 gallons (200 L) drum.	68,000.00



LE16 LABORATORY OVEN

Temperature control - Thermostat inner chamber of MS / SS

Product Code	Internal Dimension	No. Of Sleeves	Watts	Max Temp. 250 °C - MS	Max Temp. 250 °C - SS	Memert Type	
						MS ₹	SS ₹
LE16/01	(14"X14"X14") 35 x 35 x 35 Cms	2	1250	17,000.00	23,000.00	24,000.00	32,000.00
LE16/02	(18"X18"X18") 45 x 45 x 45 Cms	2	2000	24,000.00	31,000.00	30,000.00	40,000.00
LE16/03	(24"X24"X24") 60 x 60 x 60 Cms	2	3000	42,000.00	60,000.00	52,000.00	72,500.00



LE17 SOXHLET EXTRACTION MANTLES

Product Code	Catalogue	Capacity ML	No. of Flask Recesses	No. of Regulator	Total Wattage At 230 Volt	Price ₹
LE17/01	B - 1	0 - 250	3	3	450	8200.00
LE17/02	B - 2	500	3	3	600	9600.00
LE17/03	B - 3	1000	3	3	900	11000.00
LE17/04	D - 1	0 - 250	6	6	900	12,500.00
LE17/05	D - 2	500	6	6	1200	14,000.00
LE17/06	D - 3	1000	6	6	1800	16,500.00



LE18 WATER BATH (Electric single wall)

Complete unit made of SS

Product Code	Size	Holes	Price ₹
LE18/01	(14"X10"X4") 35 x 25 x 10 Cms	6	4800.00
LE18/02	(16"X12"X4") 40 x 30 x 10 Cms	12	5500.00



LE19 WATER BATH

Thermostatic controlled

Product Code	Size	Holes	Price ₹	Price ₹ (Totally SS)
LE19/01	A-Inner chamber made of SS/ Outer body made of MS 14"x 10"x 4" - 35 x 25 x 10 Cms	6	8500.00	11,000.00
LE19/02	B-Inner chamber made of SS/ Outer body made of MS 16"x 12"x 4" - 40 x 30 x 10 Cms	12	10,500.00	13,000.00



LE20 WATER STILL MANESTY TYPE (Automatic)

Wall Mounting

Product Code	Output in LTRS. / HR.	Watts	Price ₹
LE20/01	2	1500	7500.00
LE20/02	4	3000	9600.00
LE20/03	6	4000	14,000.00



LE21 OIL BATH

Electric round for round bottom flask

Product Code	Cap	Watts	Thermostatics Controlled Price ₹	Digital Controlled Price ₹
LE21/01	2 Liter	1250	15,000.00	20,000.00
LE21/02	5 Liter	2000	17,000.00	22,500.00



LE22 PORTABLE ELECTRODE DRYING OVEN

Round Thermostatically Controlled

Product Code	Watts	Size	1150°C Price ₹
LE22/01	1000	80 mm dia	3600.00
LE22/02	750	65 mm dia	3100.00



LE23 U . V CABINET

With three tubelight, short wave, long wave & day light florescent tube.

Product Code	Size Three Tube	Price ₹
LE23/01	Ultra Violet Cabinet (M.S Body)	9500.00
LE23/02	Ultra Violet Cabinet (Acrylic Body)	12,500.00
LE23/03	Ultra Violet Cabinet (S.S Body)	14,500.00



LE24 VACCUM OVEN 200°C, DOUBLE WALLED

Product Code	Working Size (Round Dia X Depth)	Watts	1150°C - Price ₹
LE24/01	22.5 x 30 Cms (9"x12")	750	40,000.00
LE24/02	30 x 38 Cms (12"x15")	1000	55,000.00
LE24/03	38 x 45 Cms (15"x18")	1250	66,000.00
LE24/04	12" x 12" x 12"		80,000.00
LE24/05	18" x 18" x 18"		1,10,000.00
LE24/06	18" x 18" x 24"		1,42,000.00



LE25 SPARE MUFFLE WOUNDED WITH HEATING ELEMENTS Made from nichrome 80 / 20 wire

Product Code	Size	Watts	930°C - Price ₹	1150°C - Price ₹
LE25/01	9" x 4" x 4"	2 K.W	9000.00	11,000.00
LE25/02	10" x 5" x 5"	2.5 K.W.	11,000.00	13,000.00
LE25/03	12" x 6" x 6"	3.5 K.W.	14,500.00	16,000.00
LE25/04	12" x 8" x 8"			20,000.00



LE26 FURNACE - HIGH TEMPERATURE (1000 °C)

Product Code	Description	Size	Watts	930°C - Price ₹	1150°C - Price ₹
LE26/01	With muffle	23 x 10 x 10 Cm	2000	25,000.00	28,000.00
LE26/02	Maxi temp.	25 x 13 x 13 Cm	2500	29,000.00	32,000.00
LE26/03	1000 °C with	30 x 15 x 15 Cm	3500	35,000.00	39,000.00
LE26/04	Electronic digital	30 x 20 x 20 Cm			45,000.00
LE26/05		45 x 23 x 23 Cm			85,000.00



LE27 MS OIL BATH SINGLE WALL WITH OIL IMMERSION Heater with control box & cooling coil

Product Code	Size	Watts		Price ₹
LE27/01	10 Ltr	(2 x 1000 W)	Three Phase	21,000.00
LE27/02	20 Ltr	(2 x 1500 W)	Three Phase	24,000.00
LE27/03	50 Ltr	(2 x 3000 W)	Three Phase	27,000.00
LE27/04	100 Ltr	(2 x 4000 W)	Three Phase	31,000.00
LE27/05	200 Ltr	(2 x 5000 W)	Three Phase	38,000.00



LE28 B . O . D INCUBATOR

Product Code	Working Size	Inner Chamber	Shelves	Price ₹
LE28/01	3 Cu. Ft. (090 Ltr)	45 x 45 x 45	2	78,000.00
LE28/02	6 Cu. Ft. (165 Ltr)	70 x 50 x 50	2	88,000.00
LE28/03	10 Cu. Ft. (280 Ltr)	100 x 55 x 55	3	95,000.00
LE28/04	12 Cu. Ft. (340 Ltr)	100 x 60 x 60	3	1,02,000.00
LE28/05	16 Cu. Ft. (440 Ltr)	115 x 65 x 65	4	1,10,000.00



LE29 ULTRASONIC CLEANER

Digital Ultrasonic cleaner with lid, timer and heater

Product Code	Cap. Approx	Wattage	Price ₹
LE29/01	2.0 Ltr.	50 W	21,000.00
LE29/02	3.0 Ltr.	100 W	27,000.00
LE29/03	6.0 Ltr.	150 W	45,000.00
LE29/04	9.0 Ltr	200 W	72,000.00
LE29/05	12.0 Ltr.	300 W	90,000.00
LE29/06	20.0 Ltr.	500 W	10,8,000.00
LE29/07	25.0 Ltr.	600 W	1,35,000.00



LE30 HOT PLATE TYPE SOXHLET

(Hot Plate Size 4" Dia)

Product Code	Flash Capacity	No. of flask	No. of Regulator	No. of Switch	Total Watts	Price ₹
LE30/01	Up 0 / 500ML	6	6	-	1500	17500.00
LE30/02	Up 0 / 500ML	3	3	-	750	12000.00



LE31 C . O . D DIGESTOR APPARATUS

Product Code	Size	Watts	Price ₹	Water Bath For C.O.D Price ₹
LE31/01	06 Sample	600	30,000.00	3000.00
LE31/02	12 Sample	1000	34,000.00	4500.00
LE31/03	15 Sample	1200	41,000.00	5500.00
LE31/04	24 Sample	1500	61,000.00	7000.00



LE32 AUTOCLAVE - VERTICAL TYPE

Inside S.S outer M.S powder coating with S.S basket

Product Code	Working Size - DIA X HT	Cap. LTR.	Price ₹
LE32/01	DIA 25 x 45 CMS HT	22	72,000.00
LE32/02	DIA 30 X 50 CMS HT	35	75,000.00
LE32/03	DIA 35 X 55 CMS HT	53	80,400.00
LE32/04	DIA 45 X 65 CMS HT	95	1,15,000.00
LE32/05	DIA 45 X 70 CMS HT	119	1,19,000.00
LE32/06	DIA 55 X 75 CMS HT	178	1,77,000.00
LE32/07	DIA 55 X 90 CMS HT	210	2,14,000.00



LE33 DIMMER SPEED REGULATOR

Product Code	Description	Price ₹
LE33/01	Dimmer speed regulator for 122-D / 128-D / 128-BD	3000.00
LE33/02	Dimmer speed regulator heavy duty	4000.00

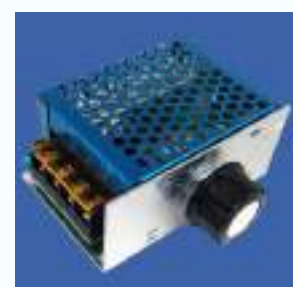

LE34 LAMINAR AIR FLOW BENCH HORIZONTAL

Product Code	Working Area	Hepa Size	Horizontal Type Price ₹
LE34/01	2' X 2' X 2'	2' X 2' X 6'	80,000.00
LE34/02	3' X 2' X 2'	3' X 2' X 6'	95,000.00
LE34/03	4' X 2' X 2'	4' X 2' X 6'	1,05,400.00
LE34/04	6' X 2' X 2'	6' X 2' X 6'	1,65,000.00



LE35 FUMMING HOOD WITH DUCTING SYSTEM

Ducting system, made of P.V.C.

Product Code	Working Area	Price ₹
LE35/01	2' X 2' X 3'	85,000.00
LE35/02	2' X 4' X 3'	1,08,000.00
LE35/03	2' X 6' X 3'	1,32,400.00





GLOBAL ANTICO PROCESS SYSTEMS PVT. LTD.

C-50/A, Sardar Estate, Road no. 4, Ajwa Road,
Vadodara - 19, Gujarat, India.

E-mail : sales@globalindus.in

Website : www.globalindus.in

Contact : +91 9978239316, +91 9909662423